

IGMI

Greene Manufacturing, Inc.

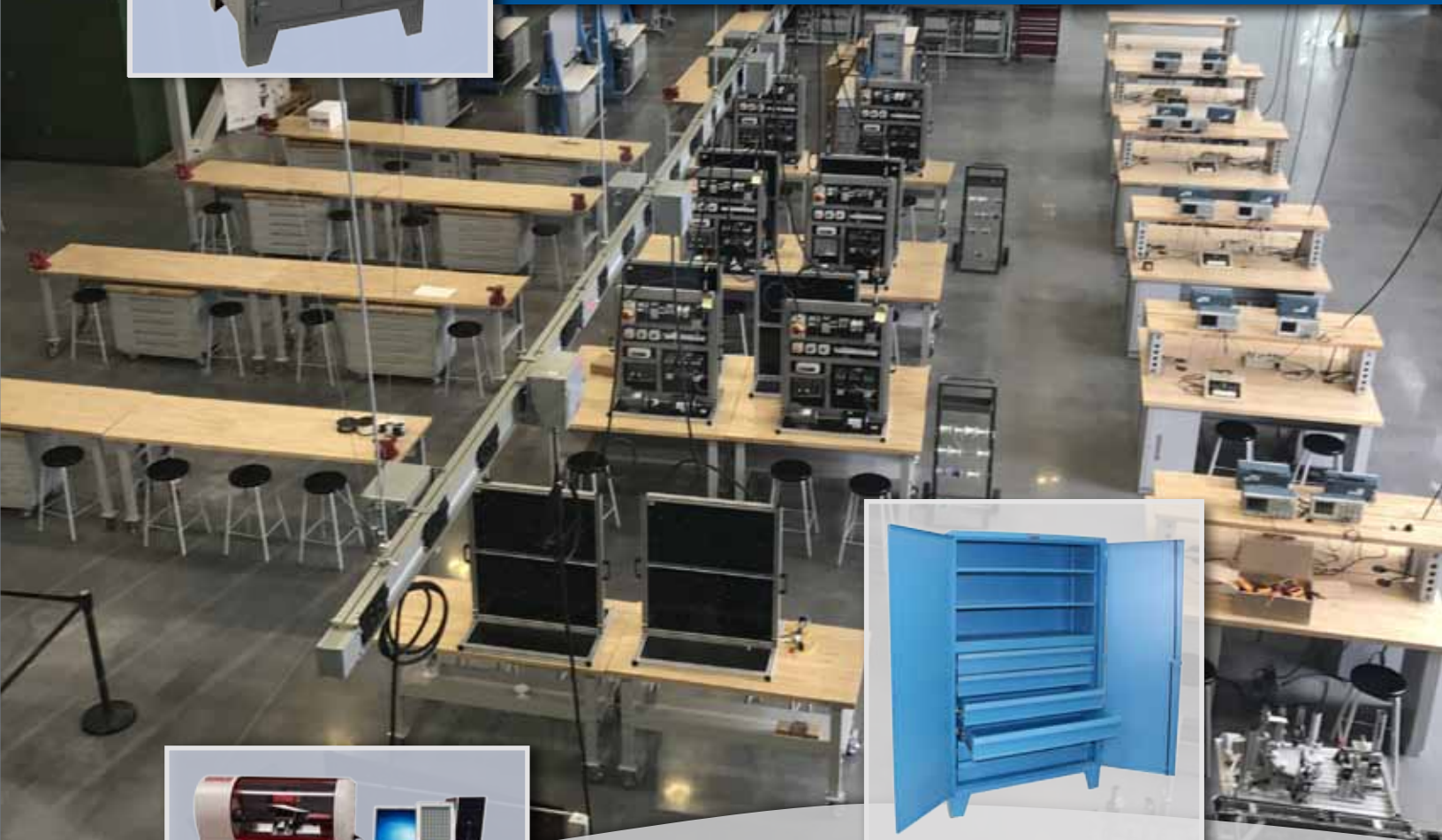

INDUSTRIAL & TECHNICAL FURNITURE



Education to Industry
Solutions for Your Workspace
and Storage Needs

A Brief History

The company was founded in 1969 in Mt. Clemens, MI. GMI began with the idea of providing quality educational furniture products with value added service. Mr. Jerry W. Greene, with his wife Wilma, designed and produced 20 original industrial arts oriented products back in 1968. These products were purchased by and installed in several local educational facilities. As these locations were toured by other educators, the quality of the products began to sell themselves. From these simple beginnings to an expanded offering of over 5000 furniture and related products, GMI has evolved into one of the premier furniture manufacturers in the educational and industrial furniture market.

We are pleased to have supplied our products and services to many of the major educational, automotive, aircraft, military, and advanced manufacturing facilities across the country.

More Than Just Great Products

We are more than just a catalog of products. Our staff will assist in the design and specification of work stations and storage equipment to assure that your lab space will work with your required equipment.

Site Planning and Room Layout:

Send GMI your project requirements and room dimensions, we will utilize our 50+ years of experience and assist you in achieving the most effective use of your space.

Custom Product Design:

GMI has a product line of over 5000 products to meet your facility's needs. If you can't find exactly what you are looking for, contact us. Our unique ability to design and custom manufacture products is affordable and provides you with the perfect fit.

Factory Trained Installation:

Whether you're on the East Coast, West Coast or somewhere in-between, GMI can provide you professional installation services. Contact our customer service department for a free estimate.

See our other product catalogs & brochures @ www.greenemfg.com.

- Welding Equipment
- Computer - CAD - Office Furniture
- Cosmetology Labs
- Science & Technology



How to Contact US.....



Call Us:

1-800-396-4642

Customer Service is available from 8:00AM -4:30PM EST, Monday through Friday. Our office is available to you from the initial planning stage through installation and for anything in between.



Email Your Request:

info@greenemfg.com

Our team can be contacted through this email for requesting quotes, shipping, customer service, order processing instructions, as well as purchase order information.



Visit Our Website:

www.greenemfg.com

Our website is continually being updated to better serve your needs and to make product information easier to find. You'll find product specifications, assembly instructions, product images, and much more.

Locate Your Local Dealer
Visit the Website or Call Us Direct

Zero Compromise Construction

Our products are built to last under extensive use in both industrial and educational settings. We use only the highest quality materials in the manufacturing of all our products while utilizing the latest technologies. Our customer service team has established a 50+ year loyalty with our customers through an unsurpassed commitment to their satisfaction.

- MADE IN THE USA
- Industry Leading Limited Lifetime Warranty
- Heavy Gauge Steel vs Thinner Gauge
- Continuous Welding vs Spot Welding
- Top Quality Hardware Components
- Designed for Use in Schools and Industry
- Durable Metal Finishes



Quality Team Members:

“The measure of a successful company is not solely based on product quality or price but on the commitment of the people who walk through its doors every day. I am proud to say that our company has an outstanding staff that is dedicated to reaching our goals, exceeding customer satisfaction, and upholding our mission statement.”

– Bruce Greene, President

IHL Series

Modular Cabinets | Benches | Tool Boxes

Page
4

Dura-Tech Series

Modular Cabinets | Benches

Page
28

CB Series

Lockers | Cabinets | Benches

Page
48

Mobile Benches & Carts

Mobile Solutions | Robotics | Tool Storage

Page
54

Workbenches

Fixed & Adj. Height | EX Series | Dura-Flex Uppers

Page
66

Shop Desks

Receiving Desks | Foreman Workstation

Page
82

Storage Cabinets

General, Personnel, Tool, Job Site & Parts Storage

Page
84

Storage Racks

General Storage | Material Handling

Page
112

Greenhouse Furniture

Agricultural Benches & Storage

Page
128

Accessories

Seating | Work Surfaces | Components

Page
130



Cabinet Features:

- All welded 14 & 16 gauge steel construction.
- 250lb. ball bearing drawer glides.
- Drawer gang locking safety system to prevent tip hazards.
- Fully opening drawers to maximize access.
- Multiple secure locking options.
- Multiple sizes & styles of base risers options.

With a variety of options and configurations the IHL Series Modular Cabinets can be configured to fit your specific storage and work space needs. IHL cabinets are constructed using all welded 16 and 14 gauge steel and will stand up to the toughest of environments. Cabinets feature drawers that fully extend on 250 lb. ball bearing drawer glides that ensure you get maximum usability from every drawer. Drawers feature a gang locking system that will allow only one drawer to be open at a time, this safety feature prevents tipping hazards when multiple loaded drawers are open at one time causing the cabinet to tip forward. To keep the contents of your cabinets secure we offer multiple locking options. Riser base options include 2”H, 4”H, 6”H, and a 4”H base with fork truck pockets for easy lifting. Optional caster kits come standard with heavy duty 5” urethane casters that include two locking swivel and two rigid casters.



Accessories:

See pgs. 136-139 for other popular IHL cabinet accessories.



Top Retainer Rails



Drawer Liners



Work Surfaces



Our IHL line of modular storage cabinets are designed with two main thoughts in mind. Maximum use of your storage space and maximum durability. Continuous welded construction using industry leading heavy gauge steel, full extension ball bearing drawer glides, and extruded aluminium handles are all standards in our cabinets. We ensure you get maximum usability from every drawer.

IHL Drawer Dimensions:

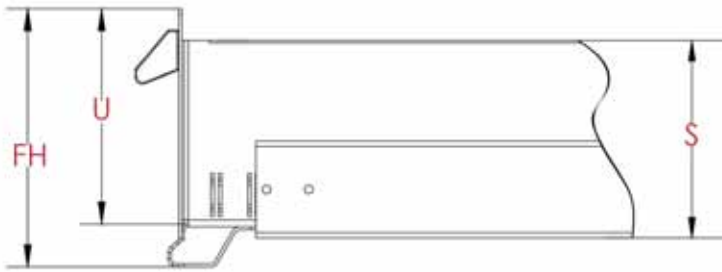

Drawer Size	Drawer Number	Front Height (FH)	Usable Height (U)	Side Height (S)
Small	75	2.98"	1.97"	1.78"
	100	4.02"	3.01"	2.32"
Medium	125	5.06"	4.05"	3.36"
	150	6.09"	5.08"	4.39"
Large	175	7.13"	6.12"	5.43"
	200	8.17"	7.16"	6.47"
Extra Large	225	9.20"	8.19"	7.50"
	250	10.24"	9.23"	8.54"
	275	11.28"	10.27"	9.58"
	300	12.31"	11.21"	10.61"

Optional drawer divider kits allow secure and organized storage of small parts, tools, or larger components. We offer many variations to tailor each drawer to the contents you plan to place in it. In addition to the dividers, drawer bottoms can be lined with a rubberized drawer material to protect sensitive parts from being damaged when opening and closing drawers.

See page 17 for additional divider kit info and ordering.



Our IHL Series Cabinets are available to be ordered in two convenient ways. The first option is by selecting from one of our pre-configured drawer stack options that offer a wide variety of drawer sizes. From large components in most drawers to entire cabinets suited for small parts or hardware storage. The second option, if you don't see the exact configuration of cabinet you need, is to design your own by ordering cabinet components separately. See pages 16 & 17 for details.

Standard Pre-Configured Cabinet Specs:

- All Welded Construction
- 16 & 14 Gauge Steel
- 250lb. Ball Bearing Drawer Guides
- Fully Extending Drawers
- Interlock Drawer System
- 12 Standard Color Choices
- 6 Standard Base Options
- 3 Standard Locking Options



How to Order IHL Pre-Configured Cabinets:

STEP 1:

Select Desired Height & Drawer Stack Configuration



STEP 2:

Select Desired Width & Depth

Insert the Width (WW) & Depth (DD) into the Part Number (See Sample Part #)

Available Widths: **16" / 18" / 24" / 30" / 36" / 48" / 56"**

Available Depths: **18" / 21" / 24" / 28"**

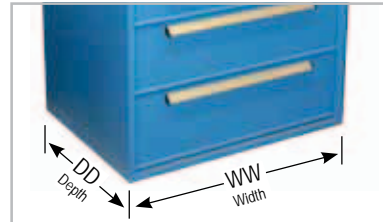

STEP 3:

Select Base Type

Add Code in Bold to Part Number (See Sample Part #)

NR = No Additional Riser

2R = 2"H Kick Riser (adds 2" to cabinet height)

4R = 4"H Kick Riser (adds 4" to cabinet height)

4FR = 4"H Riser w/ Forklift Openings (adds 4" to cabinet height)

6R = 6"H Kick Riser (adds 6" to cabinet height)

5CK = 5" Caster Kit - 2 Rigid / 2 Swivel/Locking (adds 6.5" to height)

Note: Casters on tall/narrow cabinets present a tip hazard & are not recommended.

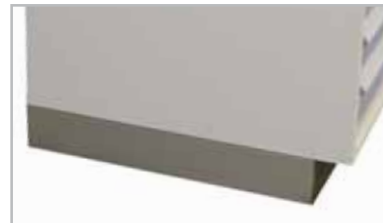

STEP 4:

Select Lock Type

Add Code in Bold to Part Number (See Sample Part #)

NL = No Lock

KA = Single Top Lock - Multiple Cabinets Keyed Alike

KD = Single Top Lock - Multiple Cabinets Keyed Different



How to Order IHL Pre-Configured Cabinets:

STEP 1:

Select Desired Height & Drawer Stack Configuration.

STEP 2:

Select Desired Width & Depth

Available Widths:
16" / 18" / 24" / 30" / 36" / 48" / 56"

Available Depths:
18" / 21" / 24" / 28"

STEP 3:

Select Base Type

- NR** = No Additional Riser
- 2R** = 2"H Kick Riser
- 4R** = 4"H Kick Riser
- 4FR** = 4"H Riser w/
Forklift Openings
- 6R** = 6"H Kick Riser
- 5CK** = 5" Caster Kit
(See note regarding
tip hazards on pg 6)

Note: Bases will increase cabinets overall height.

STEP 4:

Select Lock Type

- NL** = No Lock
- KA** = Locks Keyed Alike
- KD** = Locks Keyed Differently

Note:

Drawer Dimensions Shown on Images are the Usable Height of Each Drawer.

See Page 5 for Additional Drawer Specifications.

IHL-550 Height Cabinet 26-1/8" High

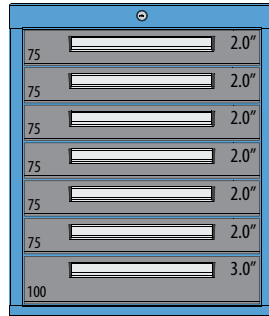

IHL-550-WWDD-701

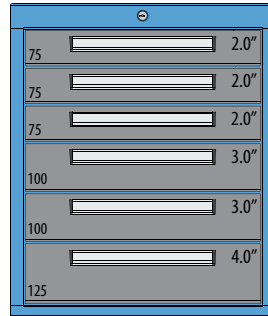

IHL-550-WWDD-601

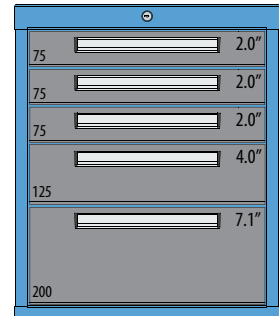

IHL-550-WWDD-501

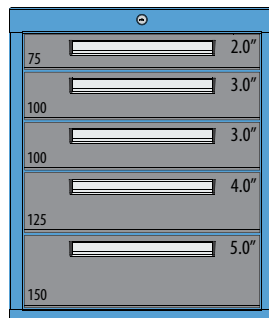

IHL-550-WWDD-502

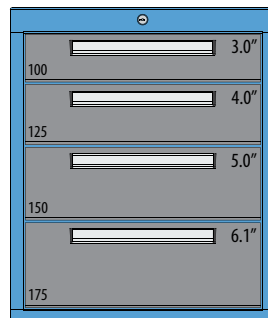

IHL-550-WWDD-401

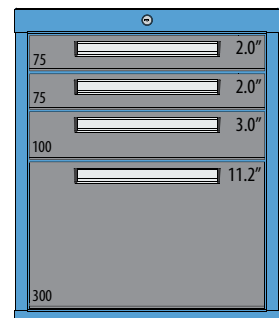

IHL-550-WWDD-402

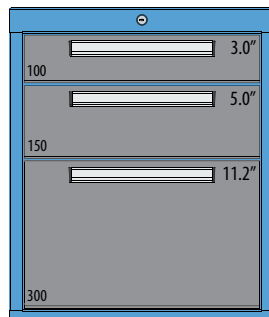

IHL-550-WWDD-301

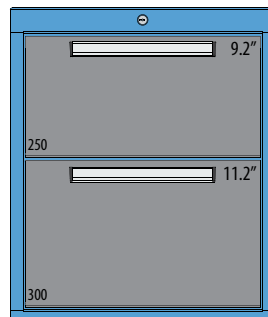

IHL-550-WWDD-201

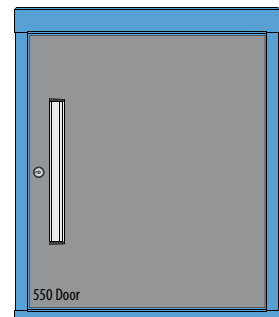

IHL-550-WWDD-001

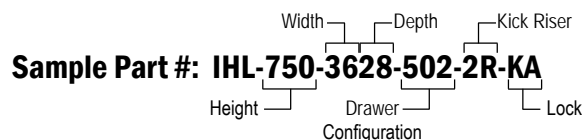

IHL-600 Height Cabinet
28-1/8" High

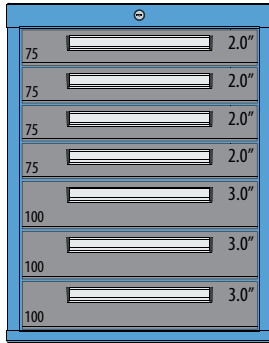

IHL-600-WWDD-701

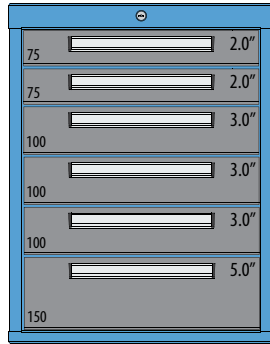

IHL-600-WWDD-601

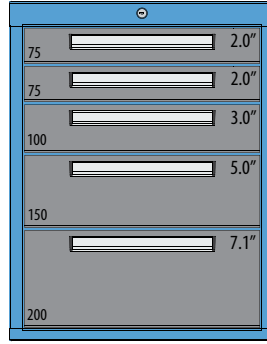

IHL-600-WWDD-501

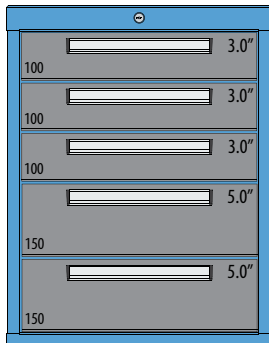

IHL-600-WWDD-502

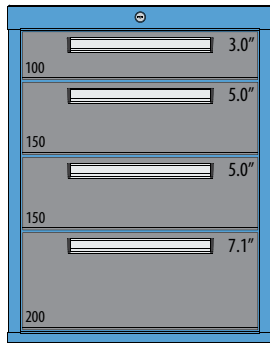

IHL-600-WWDD-401

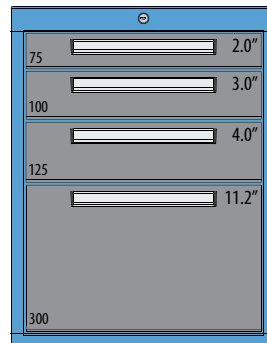

IHL-600-WWDD-402

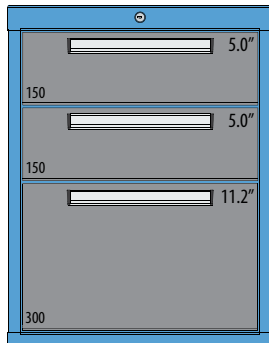

IHL-600-WWDD-301

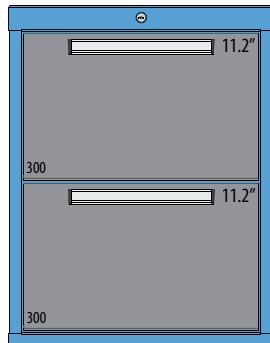

IHL-600-WWDD-201

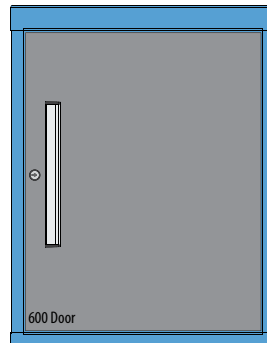

IHL-600-WWDD-001

How to Order IHL Pre-Configured Cabinets:

STEP 1:

Select Desired Height & Drawer Stack Configuration.

STEP 2:

Select Desired Width & Depth

Available Widths:
16" / 18" / 24" / 30" / 36" / 48" / 56"

Available Depths:
18" / 21" / 24" / 28"

STEP 3:

Select Base Type

- NR = No Additional Riser
- 2R = 2"H Kick Riser
- 4R = 4"H Kick Riser
- 4FR = 4"H Riser w/
Forklift Openings
- 6R = 6"H Kick Riser
- 5CK = 5" Caster Kit
(See note regarding
tip hazards on pg 6)

Note: Bases will increase cabinets overall height.

STEP 4:

Select Lock Type

- NL = No Lock
- KA = Locks Keyed Alike
- KD = Locks Keyed Differently

Note:

Drawer Dimensions Shown on Images are the Usable Height of Each Drawer.

See Page 5 for Additional Drawer Specifications.



How to Order IHL Pre-Configured Cabinets:

STEP 1:

Select Desired Height & Drawer Stack Configuration.

STEP 2:

Select Desired Width & Depth

Available Widths:

16" / 18" / 24" / 30" / 36" / 48" / 56"

Available Depths:

18" / 21" / 24" / 28"

STEP 3:

Select Base Type

NR = No Additional Riser

2R = 2"H Kick Riser

4R = 4"H Kick Riser

4FR = 4"H Riser w/
Forklift Openings

6R = 6"H Kick Riser

5CK = 5" Caster Kit
(See note regarding tip hazards on pg 6)

Note: Bases will increase cabinets overall height.

STEP 4:

Select Lock Type

NL = No Lock

KA = Locks Keyed Alike

KD = Locks Keyed Differently

Note:

Drawer Dimensions Shown on Images are the Usable Height of Each Drawer.

See Page 5 for Additional Drawer Specifications.

IHL-650 Height Cabinet 30-1/4" High

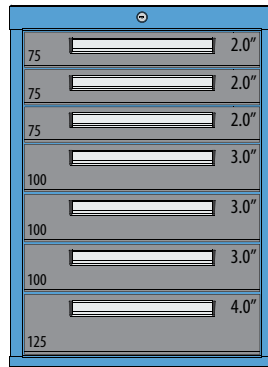

IHL-650-WWDD-701

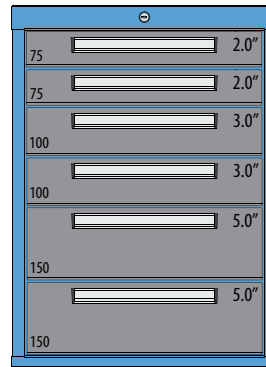

IHL-650-WWDD-601

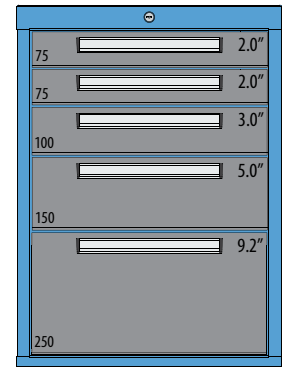

IHL-650-WWDD-501

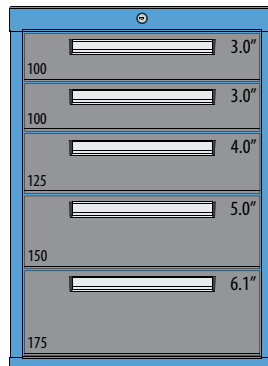

IHL-650-WWDD-502

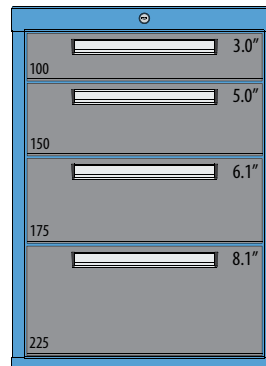

IHL-650-WWDD-401

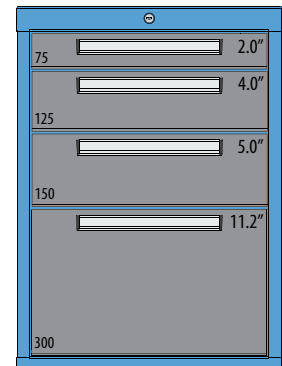

IHL-650-WWDD-402

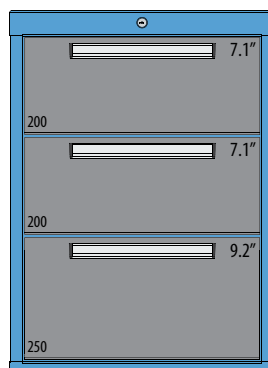

IHL-650-WWDD-301

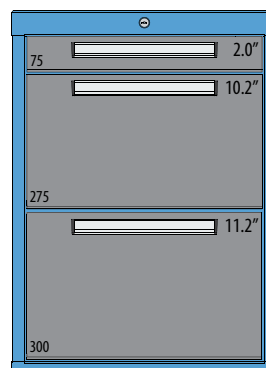

IHL-650-WWDD-302

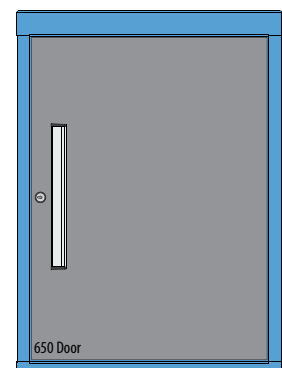

IHL-650-WWDD-001

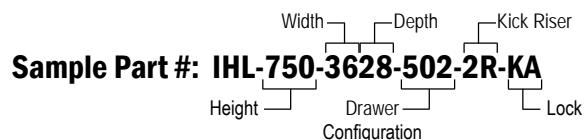

IHL-700 Height Cabinet
32-1/4" High

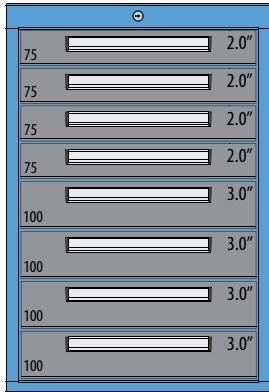

IHL-700-WWDD-801

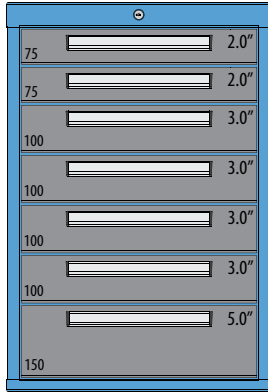

IHL-700-WWDD-701

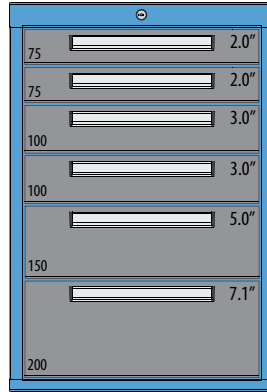

IHL-700-WWDD-601

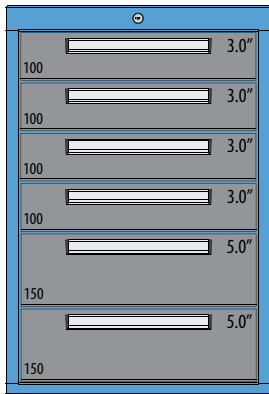

IHL-700-WWDD-602

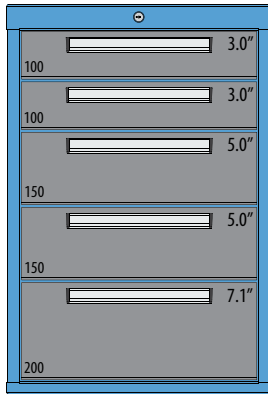

IHL-700-WWDD-501

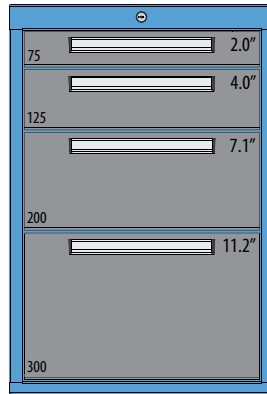

IHL-700-WWDD-401

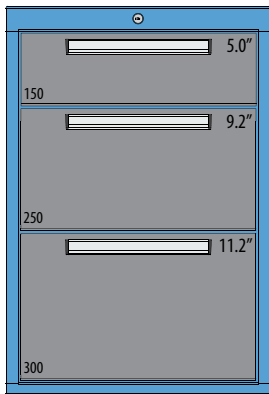

IHL-700-WWDD-301

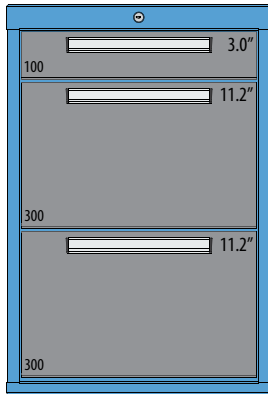

IHL-700-WWDD-302

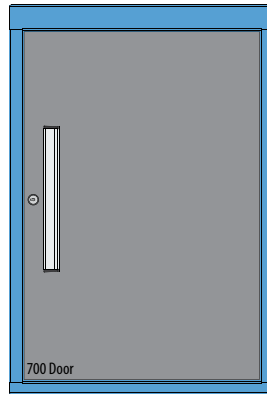

IHL-700-WWDD-001

How to Order IHL Pre-Configured Cabinets:

STEP 1:

Select Desired Height & Drawer Stack Configuration.

STEP 2:

Select Desired Width & Depth

Available Widths:
16" / 18" / 24" / 30" / 36" / 48" / 56"

Available Depths:
18" / 21" / 24" / 28"

STEP 3:

Select Base Type

- NR = No Additional Riser
- 2R = 2"H Kick Riser
- 4R = 4"H Kick Riser
- 4FR = 4"H Riser w/
Forklift Openings
- 6R = 6"H Kick Riser
- 5CK = 5" Caster Kit
(See note regarding tip hazards on pg 6)

Note: Bases will increase cabinets overall height.

STEP 4:

Select Lock Type

- NL = No Lock
- KA = Locks Keyed Alike
- KD = Locks Keyed Differently

Note:

Drawer Dimensions Shown on Images are the Usable Height of Each Drawer.

See Page 5 for Additional Drawer Specifications.



How to Order IHL Pre-Configured Cabinets:

STEP 1:

Select Desired Height & Drawer Stack Configuration.

STEP 2:

Select Desired Width & Depth

Available Widths:
16" / 18" / 24" / 30" / 36" / 48" / 56"

Available Depths:
18" / 21" / 24" / 28"

STEP 3:

Select Base Type

- NR** = No Additional Riser
- 2R** = 2"H Kick Riser
- 4R** = 4"H Kick Riser
- 4FR** = 4"H Riser w/
Forklift Openings
- 6R** = 6"H Kick Riser
- 5CK** = 5" Caster Kit
(See note regarding tip hazards on pg 6)

Note: Bases will increase cabinets overall height.

STEP 4:

Select Lock Type

- NL** = No Lock
- KA** = Locks Keyed Alike
- KD** = Locks Keyed Differently

Note:

Drawer Dimensions Shown on Images are the Usable Height of Each Drawer.

See Page 5 for Additional Drawer Specifications.

IHL-750 Height Cabinet 34-1/2" High

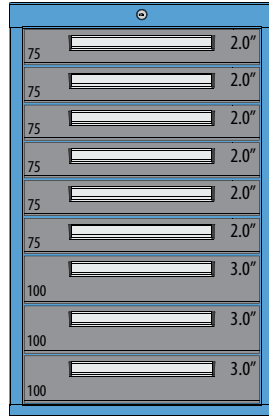

IHL-750-WWDD-901

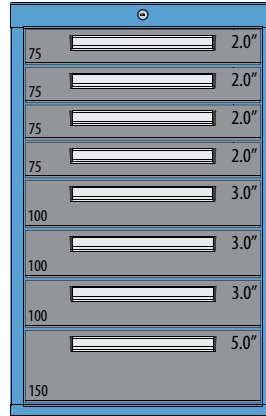

IHL-750-WWDD-801

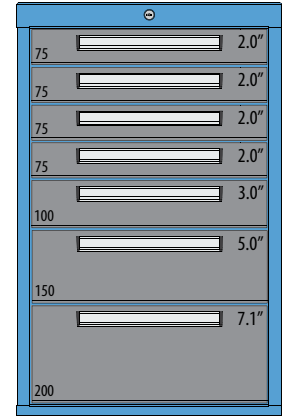

IHL-750-WWDD-701

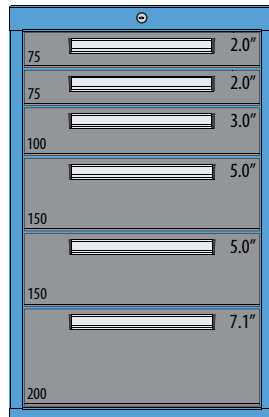

IHL-750-WWDD-601

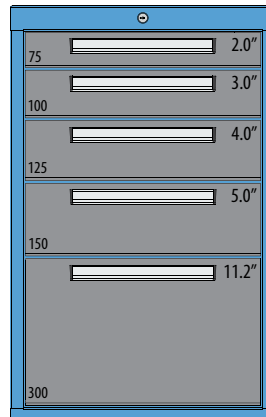

IHL-750-WWDD-501

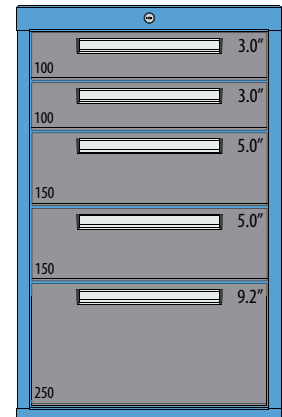

IHL-750-WWDD-502

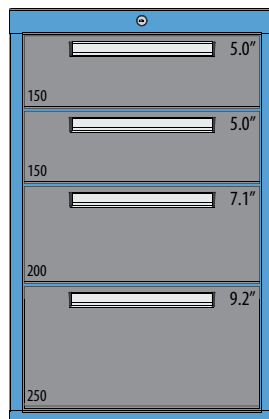

IHL-750-WWDD-401

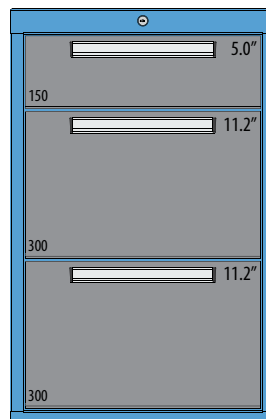

IHL-750-WWDD-301

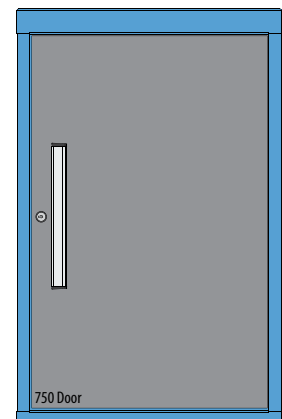

IHL-750-WWDD-001

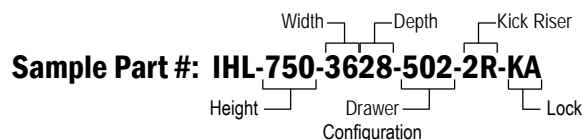

IHL-900 Height Cabinet
40-1/2" High

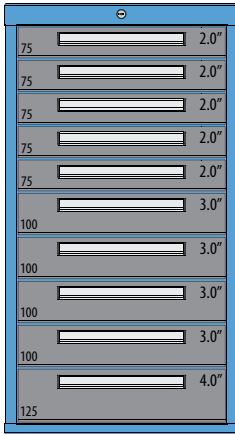

IHL-900-WWDD-100

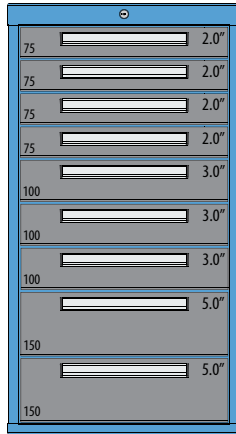

IHL-900-WWDD-901

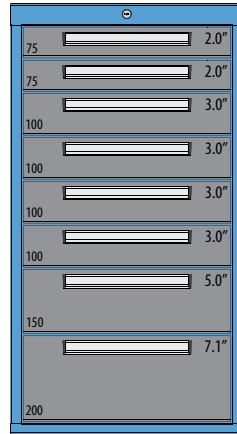

IHL-900-WWDD-801

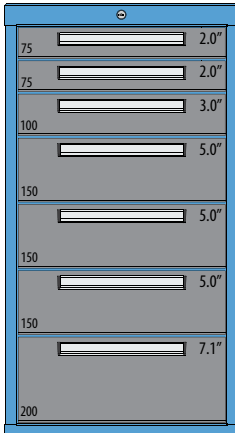

IHL-900-WWDD-701

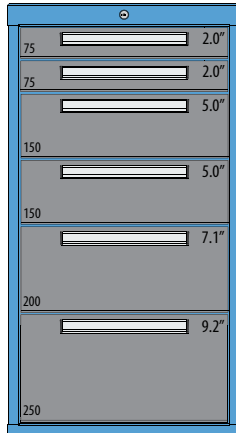

IHL-900-WWDD-601

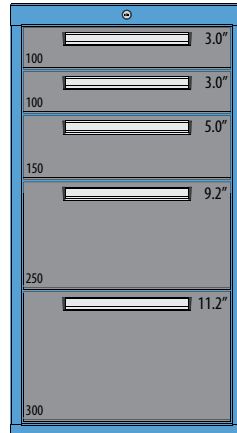

IHL-900-WWDD-501

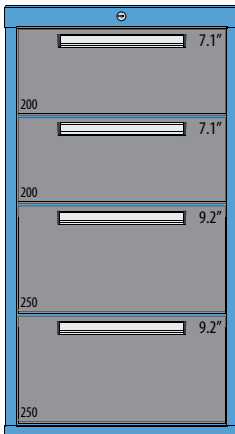

IHL-900-WWDD-401

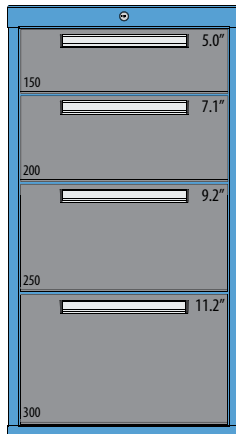

IHL-900-WWDD-402

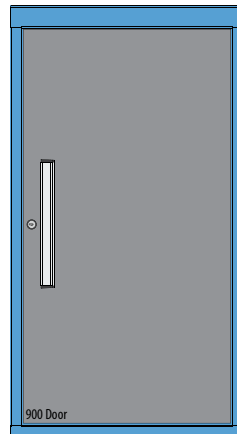

IHL-900-WWDD-001

How to Order IHL Pre-Configured Cabinets:

STEP 1:
Select Desired Height & Drawer Stack Configuration.

STEP 2:
Select Desired Width & Depth

Available Widths:
16" / 18" / 24" / 30" / 36" / 48" / 56"

Available Depths:
18" / 21" / 24" / 28"

STEP 3:
Select Base Type

- NR** = No Additional Riser
- 2R** = 2"H Kick Riser
- 4R** = 4"H Kick Riser
- 4FR** = 4"H Riser w/
Forklift Openings
- 6R** = 6"H Kick Riser
- 5CK** = 5" Caster Kit
(See note regarding tip hazards on pg 6)

Note: Bases will increase cabinets overall height.

STEP 4:
Select Lock Type

- NL** = No Lock
- KA** = Locks Keyed Alike
- KD** = Locks Keyed Differently

Note:
Drawer Dimensions Shown on Images are the Usable Height of Each Drawer.

See Page 5 for Additional Drawer Specifications.



How to Order IHL Pre-Configured Cabinets:

STEP 1:

Select Desired Height & Drawer Stack Configuration.

STEP 2:

Select Desired Width & Depth

Available Widths:
16" / 18" / 24" / 30" / 36" / 48" / 56"

Available Depths:
18" / 21" / 24" / 28"

STEP 3:

Select Base Type

- NR** = No Additional Riser
- 2R** = 2"H Kick Riser
- 4R** = 4"H Kick Riser
- 4FR** = 4"H Riser w/
Forklift Openings
- 6R** = 6"H Kick Riser
- 5CK** = 5" Caster Kit
(See note regarding tip hazards on pg 6)

Note: Bases will increase cabinets overall height.

STEP 4:

Select Lock Type

- NL** = No Lock
- KA** = Locks Keyed Alike
- KD** = Locks Keyed Differently

Note:

Drawer Dimensions Shown on Images are the Usable Height of Each Drawer.

See Page 5 for Additional Drawer Specifications.

IHL-1000 Height Cabinet 44-3/4" High

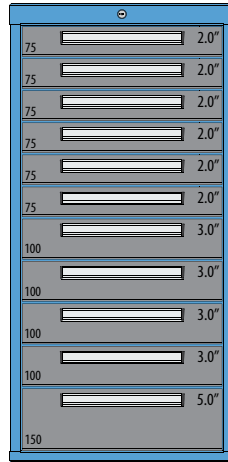

IHL-1000-WWDD-1101

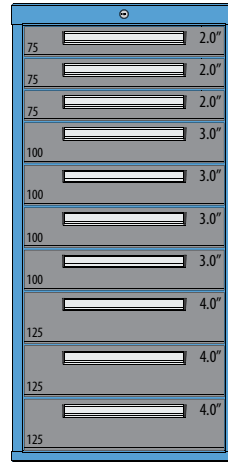

IHL-1000-WWDD-1001

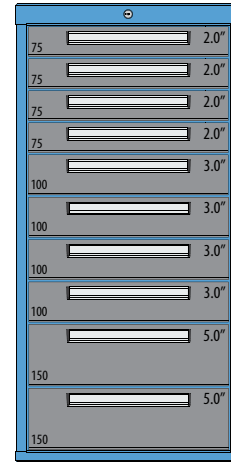

IHL-1000-WWDD-1002

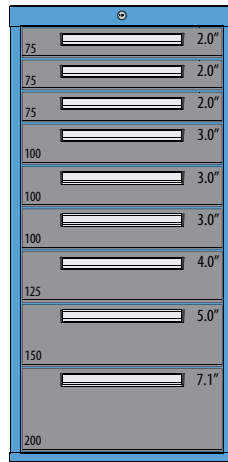

IHL-1000-WWDD-901

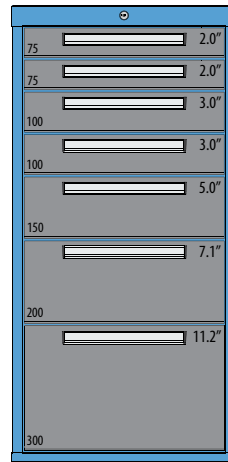

IHL-1000-WWDD-701

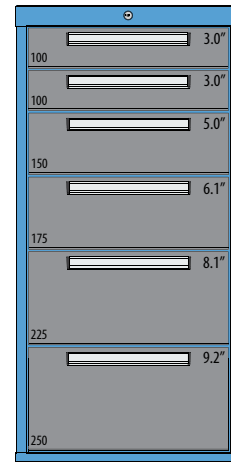

IHL-1000-WWDD-601

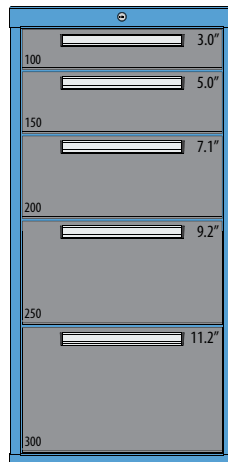

IHL-1000-WWDD-501

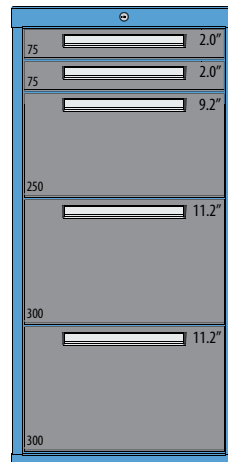

IHL-1000-WWDD-502

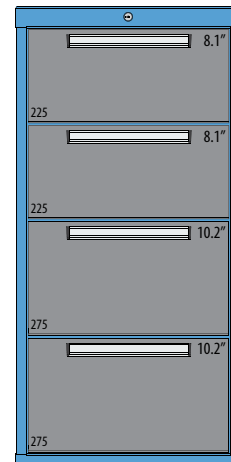

IHL-1000-WWDD-401



IHL-1200 Height Cabinet
53" High

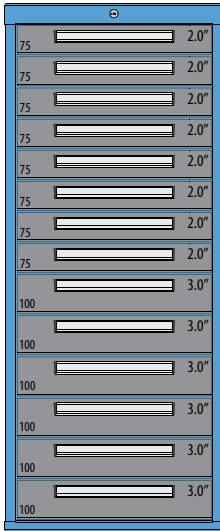

IHL-1200-WWDD-1401

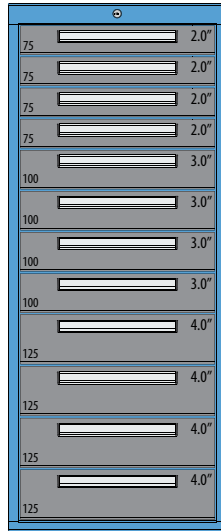

IHL-1200-WWDD-1201

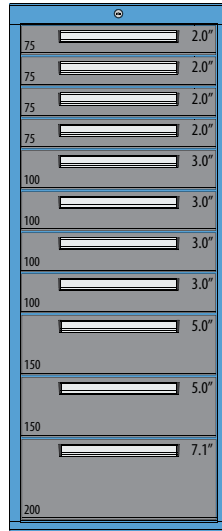

IHL-1200-WWDD-1101

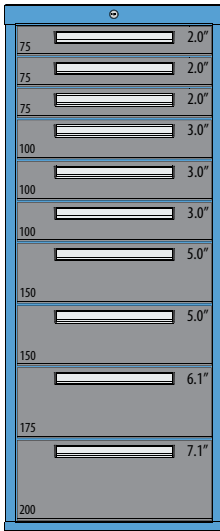

IHL-1200-WWDD-1001

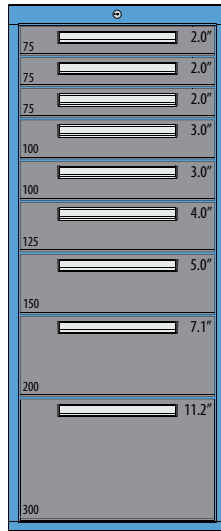

IHL-1200-WWDD-901

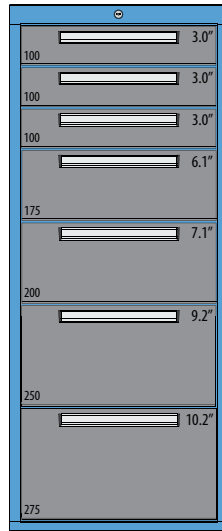

IHL-1200-WWDD-701

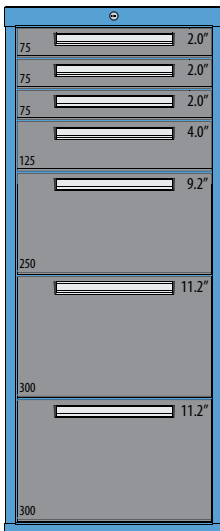

IHL-1200-WWDD-702

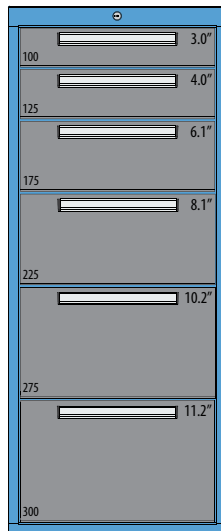

IHL-1200-WWDD-601

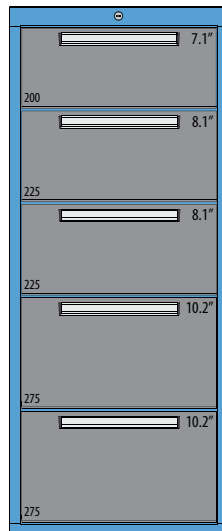

IHL-1200-WWDD-501

How to Order IHL Pre-Configured Cabinets:

STEP 1:
Select Desired Height & Drawer Stack Configuration.

STEP 2:
Select Desired Width & Depth

Available Widths:
16" / 18" / 24" / 30" / 36" / 48" / 56"

Available Depths:
18" / 21" / 24" / 28"

STEP 3:
Select Base Type

- NR** = No Additional Riser
- 2R** = 2"H Kick Riser
- 4R** = 4"H Kick Riser
- 4FR** = 4"H Riser w/
Forklift Openings
- 6R** = 6"H Kick Riser
- 5CK** = 5" Caster Kit
(See note regarding tip hazards on pg 6)

Note: Bases will increase cabinets overall height.

STEP 4:
Select Lock Type

- NL** = No Lock
- KA** = Locks Keyed Alike
- KD** = Locks Keyed Differently

Note:
Drawer Dimensions Shown on Images are the Usable Height of Each Drawer.

See Page 5 for Additional Drawer Specifications.

How to Order IHL Pre-Configured Cabinets:

STEP 1:

Select Desired Height & Drawer Stack Configuration.

STEP 2:

Select Desired Width & Depth

Available Widths:
16" / 18" / 24" / 30" / 36" / 48" / 56"

Available Depths:
18" / 21" / 24" / 28"

STEP 3:

Select Base Type

- NR** = No Additional Riser
- 2R** = 2"H Kick Riser
- 4R** = 4"H Kick Riser
- 4FR** = 4"H Riser w/
Forklift Openings
- 6R** = 6"H Kick Riser
- 5CK** = 5" Caster Kit
(See note regarding
tip hazards on pg 6)

Note: Bases will increase cabinets overall height.

STEP 4:

Select Lock Type

- NL** = No Lock
- KA** = Locks Keyed Alike
- KD** = Locks Keyed Differently

Note:

Drawer Dimensions Shown on Images are the Usable Height of Each Drawer.

See Page 5 for Additional Drawer Specifications.

IHL-1350 Height Cabinet 59-1/4" High

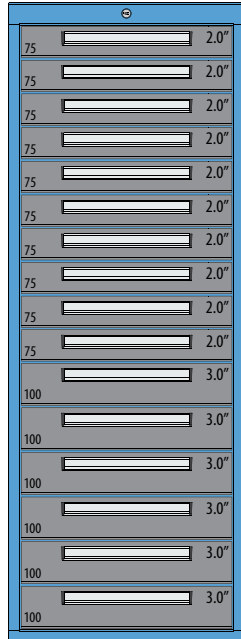

IHL-1350-WWDD-1601

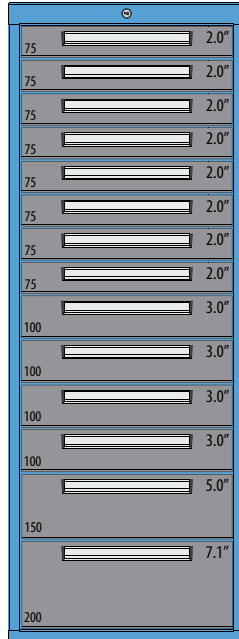

IHL-1350-WWDD-1401

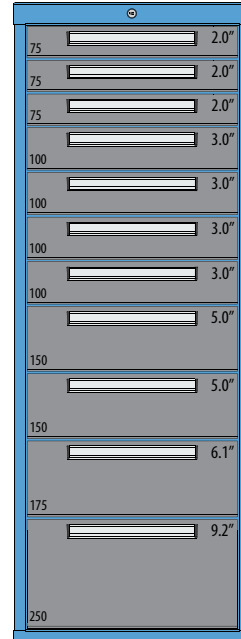

IHL-1350-WWDD-1101

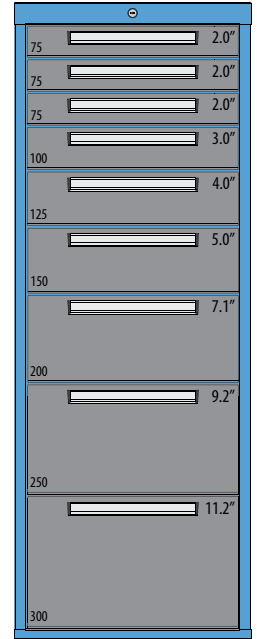

IHL-1350-WWDD-901

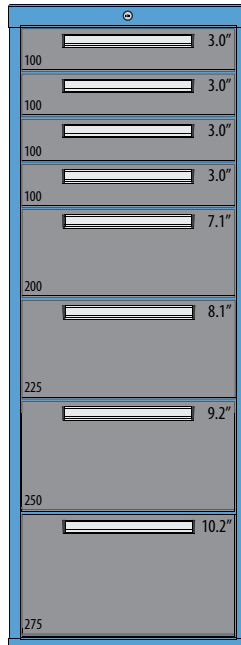

IHL-1350-WWDD-801

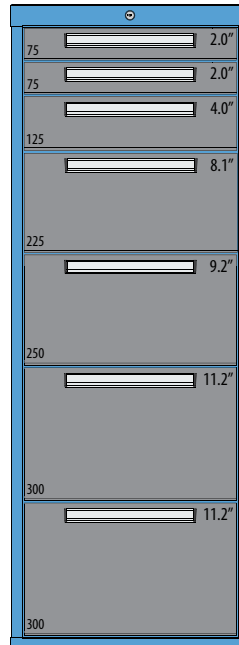

IHL-1350-WWDD-701

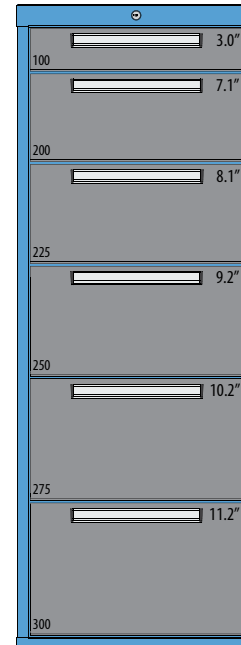

IHL-1350-WWDD-601

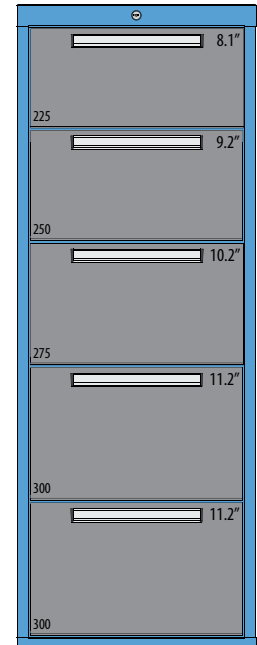

IHL-1350-WWDD-501

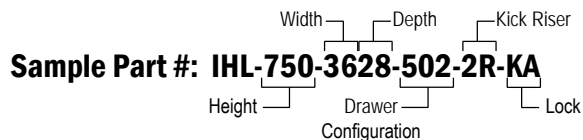

Our IHL Series Cabinets are available in many popular pre-configured options. If you can not find the perfect drawer and size configuration, you can design your own cabinet by ordering your cabinet components separately. Follow these steps to configure a cabinet that will perfectly match the contents you plan on storing in it.

Width
Depth
Lock
Sample Shell Part #: IHL-750-3628-2R-KA
Height
Kick Riser

Configure the Cabinet Shell:

STEP 1:

Select Desired Height

Note: Base Selection Will Add to Overall Cabinet Height

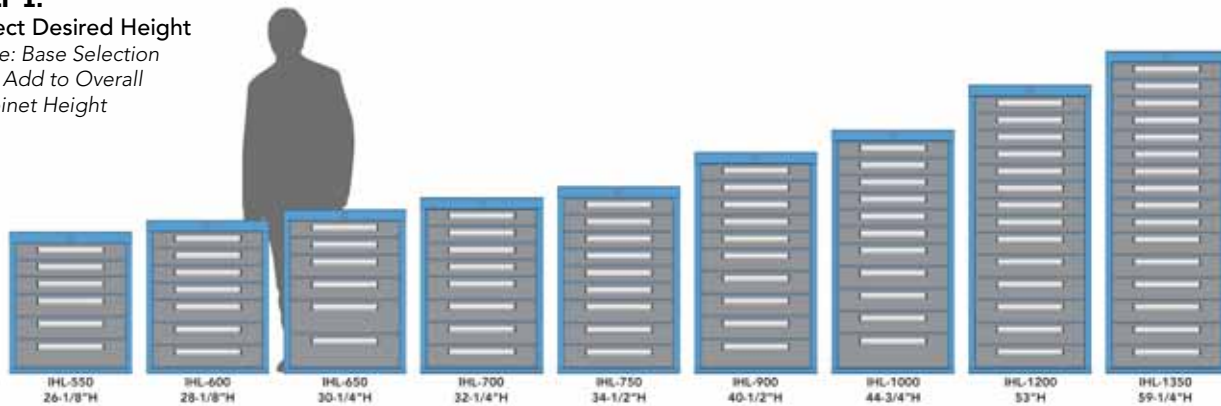

STEP 2:

Select Desired Width & Depth

Insert the Width (WW) & Depth (DD) into the Part Number (See Sample Part #)

Available Widths: **16" / 18" / 24" / 30" / 36" / 48" / 56"**

Available Depths: **18" / 21" / 24" / 28"**

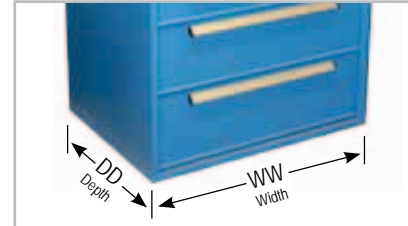

STEP 3:

Select Base Type

Add Code in Bold to Part Number (See Sample Part #)

NR = No Additional Riser

2R = 2"H Kick Riser (adds 2" to cabinet height)

4R = 4"H Kick Riser (adds 4" to cabinet height)

4FR = 4"H Riser w/ Forklift Openings (adds 4" to cabinet height)

6R = 6"H Kick Riser (adds 6" to cabinet height)

5CK = 5" Caster Kit - 2 Rigid / 2 Swivel/Locking (adds 6.5" to height)

Note: Casters on tall/narrow cabinets present a tip hazard & are not recommended.

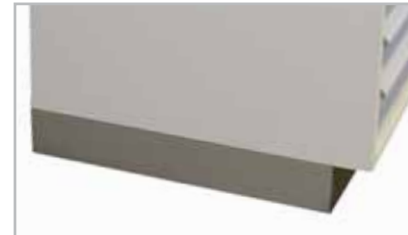

STEP 4:

Select Lock Type

Add Code in Bold to Part Number (See Sample Part #)

NL = No Lock

KA = Single Top Lock - Multiple Cabinets Keyed Alike

KD = Single Top Lock - Multiple Cabinets Keyed Different



Configure the Drawers or Door:

STEP 5:

Use our simple formula for drawer configuration. If ordering an IHL-750-3628 height cabinet you can select any variety of drawer numbers as long as they total 750 for an IHL-750 height cabinet.

Drawer Stack Example:

Drawer No's.:

- 100 - (Part # IHL-100-3628)
- 100 - (Part # IHL-100-3628)
- 150 - (Part # IHL-150-3628)
- 200 - (Part # IHL-200-3628)
- ±200 - (Part # IHL-200-3628)
- 750 - (Total of drawer numbers is equal to cabinet height)

Sample Drawer Part #:

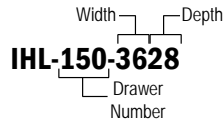

Drawer Size	Drawer Number	Front Height (FH)	Usable Height (U)	Side Height (S)
Small	75	2.98"	1.97"	1.78"
	100	4.02"	3.01"	2.32"
Medium	125	5.06"	4.05"	3.36"
	150	6.09"	5.08"	4.39"
Large	175	7.13"	6.12"	5.43"
	200	8.17"	7.16"	6.47"
Extra Large	225	9.20"	8.19"	7.50"
	250	10.24"	9.23"	8.54"
	275	11.28"	10.27"	9.58"
	300	12.31"	11.21"	10.61"

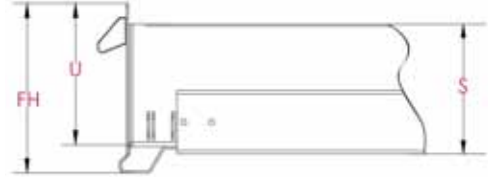

Door Cabinets:

For a door cabinet use the "DOR" code in place of the drawer number, see sample number. Door cabinets include adjustable interior shelf.



Optional Drawer Divider Kits:

Divider kits are available for all sizes of IHL drawers. The dividers keep parts of all sizes organized and readily available. To order, please provide us with the divider kit selection, drawer number (height), and the width & depth of the cabinet.

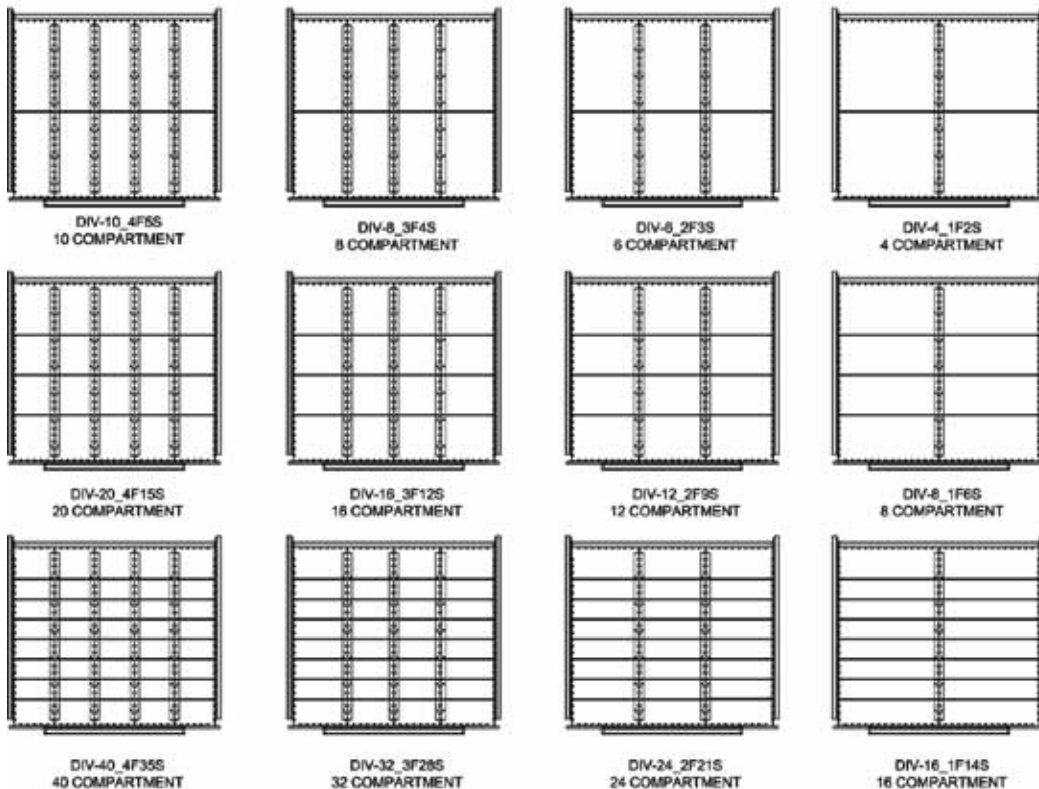

IHL Heavy Duty Workbenches are constructed using all welded 16 and 14 gauge steel and will stand up to industrial environments, educational settings, or any garage workshop.

Cabinets feature drawers that fully extend on 250 lb. ball bearing drawer glides that ensure you get maximum usability from every drawer. The contents of your drawers and cabinets remain secure with a keyed cylinder style lock. Drawers are configured in a variety of heights that range from our smallest 3"H drawer face height up to 12"H for storage of larger components. Door cabinets come standard with one adjustable shelf and doors mounted on heavy duty hinges. Drawer faces are inset within the workstation for a clean and professional look.



IHL Pre-engineered workstations are equipped with the following standard features:

- All Welded Construction
- 16 & 14 Gauge Steel
- 250lb. Ball Bearing Drawer Guides
- Fully Extending Drawers
- Rear Stringer
- 14 Ga Channel Formed Leg on Single Cabinet Stations
- Doors Mounted on Heavy Duty Hinges
- 2"H Cabinet Recessed Kick Riser



IHL Drawer Dimensions:

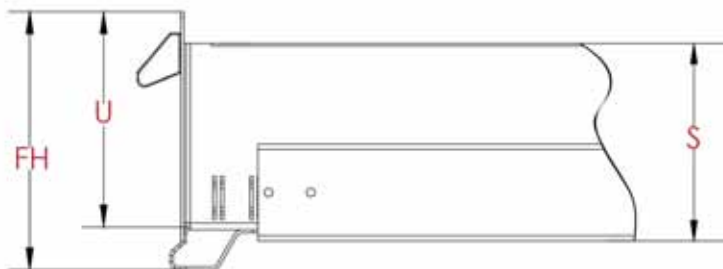

Drawer Size	Drawer Number	Front Height (FH)	Usable Height (U)	Side Height (S)
Small	75	2.98"	1.97"	1.78"
	100	4.02"	3.01"	2.32"
Medium	125	5.06"	4.05"	3.36"
	150	6.09"	5.08"	4.39"
Large	175	7.13"	6.12"	5.43"
	200	8.17"	7.16"	6.47"
Extra Large	225	9.20"	8.19"	7.50"
	250	10.24"	9.23"	8.54"
	275	11.28"	10.27"	9.58"
	300	12.31"	11.21"	10.61"



- Worksurface Area: 60"W x 30"D
- LH Single Door Cabinet: 18"W x 28"D
- Single Door w/ (1) Adjustable Shelf
- Rear Support Stringer
- RH Channel Formed Leg
- 2"H Kick Riser

- Worksurface Area: 60"W x 30"D
- LH 3 Drawer Cabinet: 18"W x 28"D
- Drawer No's.: 150 / 250 / 300
- Rear Support Stringer
- RH Channel Formed Leg
- 2"H Kick Riser

Part #	Overall Size	Top Description
IHL-700WB-3060-001-BL-S	30"D x 60"W x 36.25"H	Painted Steel - 2"H
IHL-700WB-3060-001-BL-M	30"D x 60"W x 36.00"H	Hardwood/Maple - 1.75"H
IHL-700WB-3060-001-BL-SS	30"D x 60"W x 36.25"H	Stainless Steel - 2"H
IHL-700WB-3060-001-BL-LE	30"D x 60"W x 35.50"H	ESD Laminate - 1.25"H
IHL-700WB-3060-001-BL-L	30"D x 60"W x 35.50"H	Plastic Laminate - 1.25"H

Part #	Overall Size	Top Description
IHL-700WB-3060-301-BL-S	30"D x 60"W x 36.25"H	Painted Steel - 2"H
IHL-700WB-3060-301-BL-M	30"D x 60"W x 36.00"H	Hardwood/Maple - 1.75"H
IHL-700WB-3060-301-BL-SS	30"D x 60"W x 36.25"H	Stainless Steel - 2"H
IHL-700WB-3060-301-BL-LE	30"D x 60"W x 35.50"H	ESD Laminate - 1.25"H
IHL-700WB-3060-301-BL-L	30"D x 60"W x 35.50"H	Plastic Laminate - 1.25"H

Worksurface Types:



- Worksurface Area: 60"W x 30"D
- LH 3 Drawer Cabinet: 18"W x 28"D
- Drawer No's.: 100 / 300 / 300
- Rear Support Stringer
- RH Channel Formed Leg
- 2"H Kick Riser

- Worksurface Area: 60"W x 30"D
- LH 4 Drawer Cabinet: 18"W x 28"D
- Drawer No's.: 75 / 125 / 200 / 300
- Rear Support Stringer
- RH Channel Formed Leg
- 2"H Kick Riser

Part #	Overall Size	Top Description
IHL-700WB-3060-302-BL-S	30"D x 60"W x 36.25"H	Painted Steel - 2"H
IHL-700WB-3060-302-BL-M	30"D x 60"W x 36.00"H	Hardwood/Maple - 1.75"H
IHL-700WB-3060-302-BL-SS	30"D x 60"W x 36.25"H	Stainless Steel - 2"H
IHL-700WB-3060-302-BL-LE	30"D x 60"W x 35.50"H	ESD Laminate - 1.25"H
IHL-700WB-3060-302-BL-L	30"D x 60"W x 35.50"H	Plastic Laminate - 1.25"H

Part #	Overall Size	Top Description
IHL-700WB-3060-401-BL-S	30"D x 60"W x 36.25"H	Painted Steel - 2"H
IHL-700WB-3060-401-BL-M	30"D x 60"W x 36.00"H	Hardwood/Maple - 1.75"H
IHL-700WB-3060-401-BL-SS	30"D x 60"W x 36.25"H	Stainless Steel - 2"H
IHL-700WB-3060-401-BL-LE	30"D x 60"W x 35.50"H	ESD Laminate - 1.25"H
IHL-700WB-3060-401-BL-L	30"D x 60"W x 35.50"H	Plastic Laminate - 1.25"H



- Worksurface Area: 60"W x 30"D
- LH 5 Drawer Cabinet: 18"W x 28"D
- Drawer No's.: 100(2) / 150(2) / 200
- Rear Support Stringer
- RH Channel Formed Leg
- 2"H Kick Riser

- Worksurface Area: 60"W x 30"D
- LH 6 Drawer Cabinet: 18"W x 28"D
- Drawer No's.: 75(2) / 100(2) / 150 / 200
- Rear Support Stringer
- RH Channel Formed Leg
- 2"H Kick Riser

Part #	Overall Size	Top Description
IHL-700WB-3060-501-BL-S	30"D x 60"W x 36.25"H	Painted Steel - 2"H
IHL-700WB-3060-501-BL-M	30"D x 60"W x 36.00"H	Hardwood/Maple - 1.75"H
IHL-700WB-3060-501-BL-SS	30"D x 60"W x 36.25"H	Stainless Steel - 2"H
IHL-700WB-3060-501-BL-LE	30"D x 60"W x 35.50"H	ESD Laminate - 1.25"H
IHL-700WB-3060-501-BL-L	30"D x 60"W x 35.50"H	Plastic Laminate - 1.25"H

Part #	Overall Size	Top Description
IHL-700WB-3060-601-BL-S	30"D x 60"W x 36.25"H	Painted Steel - 2"H
IHL-700WB-3060-601-BL-M	30"D x 60"W x 36.00"H	Hardwood/Maple - 1.75"H
IHL-700WB-3060-601-BL-SS	30"D x 60"W x 36.25"H	Stainless Steel - 2"H
IHL-700WB-3060-601-BL-LE	30"D x 60"W x 35.50"H	ESD Laminate - 1.25"H
IHL-700WB-3060-601-BL-L	30"D x 60"W x 35.50"H	Plastic Laminate - 1.25"H

Worksurface Types:



Painted Steel



Hardwood/Maple



Stainless Steel



ESD Laminate



Plastic Laminate w/ Armor Edge



- Worksurface Area: 60"W x 30"D
- LH 6 Drawer Cabinet: 18"W x 28"D
- Drawer No's.: 100(4) / 150(2)
- Rear Support Stringer
- RH Channel Formed Leg
- 2"H Kick Riser

- Worksurface Area: 60"W x 30"D
- LH 7 Drawer Cabinet: 18"W x 28"D
- Drawer No's.: 75(2) / 100(4) / 150
- Rear Support Stringer
- RH Channel Formed Leg
- 2"H Kick Riser

Part #	Overall Size	Top Description
IHL-700WB-3060-602-BL-S	30"D x 60"W x 36.25"H	Painted Steel - 2"H
IHL-700WB-3060-602-BL-M	30"D x 60"W x 36.00"H	Hardwood/Maple - 1.75"H
IHL-700WB-3060-602-BL-SS	30"D x 60"W x 36.25"H	Stainless Steel - 2"H
IHL-700WB-3060-602-BL-LE	30"D x 60"W x 35.50"H	ESD Laminate - 1.25"H
IHL-700WB-3060-602-BL-L	30"D x 60"W x 35.50"H	Plastic Laminate - 1.25"H

Part #	Overall Size	Top Description
IHL-700WB-3060-701-BL-S	30"D x 60"W x 36.25"H	Painted Steel - 2"H
IHL-700WB-3060-701-BL-M	30"D x 60"W x 36.00"H	Hardwood/Maple - 1.75"H
IHL-700WB-3060-701-BL-SS	30"D x 60"W x 36.25"H	Stainless Steel - 2"H
IHL-700WB-3060-701-BL-LE	30"D x 60"W x 35.50"H	ESD Laminate - 1.25"H
IHL-700WB-3060-701-BL-L	30"D x 60"W x 35.50"H	Plastic Laminate - 1.25"H



- Worksurface Area: 60"W x 30"D
- LH 8 Drawer Cabinet: 18"W x 28"D
- Drawer No's.: 75(4) / 100(4)
- Rear Support Stringer
- RH Channel Formed Leg
- 2"H Kick Riser

- Worksurface Area: 72"W x 30"D
- LH Single Door Cabinet: 24"W x 28"D
- Single Door w/ (1) Adjustable Shelf
- Rear Support Stringer
- RH Channel Formed Leg
- 2"H Kick Riser

Part #	Overall Size	Top Description
IHL-700WB-3060-801-BL-S	30"D x 60"W x 36.25"H	Painted Steel - 2"H
IHL-700WB-3060-801-BL-M	30"D x 60"W x 36.00"H	Hardwood/Maple - 1.75"H
IHL-700WB-3060-801-BL-SS	30"D x 60"W x 36.25"H	Stainless Steel - 2"H
IHL-700WB-3060-801-BL-LE	30"D x 60"W x 35.50"H	ESD Laminate - 1.25"H
IHL-700WB-3060-801-BL-L	30"D x 60"W x 35.50"H	Plastic Laminate - 1.25"H

Part #	Overall Size	Top Description
IHL-700WB-3072-001-BL-S	30"D x 72"W x 36.25"H	Painted Steel - 2"H
IHL-700WB-3072-001-BL-M	30"D x 72"W x 36.00"H	Hardwood/Maple - 1.75"H
IHL-700WB-3072-001-BL-SS	30"D x 72"W x 36.25"H	Stainless Steel - 2"H
IHL-700WB-3072-001-BL-LE	30"D x 72"W x 35.50"H	ESD Laminate - 1.25"H
IHL-700WB-3072-001-BL-L	30"D x 72"W x 35.50"H	Plastic Laminate - 1.25"H

Worksurface Types:



- Worksurface Area: 72"W x 30"D
- LH 3 Drawer Cabinet: 24"W x 28"D
- Drawer No's.: 150 / 250 / 300
- Rear Support Stringer
- RH Channel Formed Leg
- 2"H Kick Riser

- Worksurface Area: 72"W x 30"D
- LH 4 Drawer Cabinet: 24"W x 28"D
- Drawer No's.: 75 / 125 / 200 / 300
- Rear Support Stringer
- RH Channel Formed Leg
- 2"H Kick Riser

Part #	Overall Size	Top Description
IHL-700WB-3072-301-BL-S	30"D x 72"W x 36.25"H	Painted Steel - 2"H
IHL-700WB-3072-301-BL-M	30"D x 72"W x 36.00"H	Hardwood/Maple - 1.75"H
IHL-700WB-3072-301-BL-SS	30"D x 72"W x 36.25"H	Stainless Steel - 2"H
IHL-700WB-3072-301-BL-LE	30"D x 72"W x 35.50"H	ESD Laminate - 1.25"H
IHL-700WB-3072-301-BL-L	30"D x 72"W x 35.50"H	Plastic Laminate - 1.25"H

Part #	Overall Size	Top Description
IHL-700WB-3072-401-BL-S	30"D x 72"W x 36.25"H	Painted Steel - 2"H
IHL-700WB-3072-401-BL-M	30"D x 72"W x 36.00"H	Hardwood/Maple - 1.75"H
IHL-700WB-3072-401-BL-SS	30"D x 72"W x 36.25"H	Stainless Steel - 2"H
IHL-700WB-3072-401-BL-LE	30"D x 72"W x 35.50"H	ESD Laminate - 1.25"H
IHL-700WB-3072-401-BL-L	30"D x 72"W x 35.50"H	Plastic Laminate - 1.25"H



- Worksurface Area: 72"W x 30"D
- LH 6 Drawer Cabinet: 24"W x 28"D
- Drawer No's.: 75(2) / 100(2) / 150 / 200
- Rear Support Stringer
- RH Channel Formed Leg
- 2"H Kick Riser

- Worksurface Area: 72"W x 30"D
- LH 7 Drawer Cabinet: 24"W x 28"D
- Drawer No's.: 75(2) / 100(4) / 150
- Rear Support Stringer
- RH Channel Formed Leg
- 2"H Kick Riser

Part #	Overall Size	Top Description
IHL-700WB-3072-601-BL-S	30"D x 72"W x 36.25"H	Painted Steel - 2"H
IHL-700WB-3072-601-BL-M	30"D x 72"W x 36.00"H	Hardwood/Maple - 1.75"H
IHL-700WB-3072-601-BL-SS	30"D x 72"W x 36.25"H	Stainless Steel - 2"H
IHL-700WB-3072-601-BL-LE	30"D x 72"W x 35.50"H	ESD Laminate - 1.25"H
IHL-700WB-3072-601-BL-L	30"D x 72"W x 35.50"H	Plastic Laminate - 1.25"H

Part #	Overall Size	Top Description
IHL-700WB-3072-701-BL-S	30"D x 72"W x 36.25"H	Painted Steel - 2"H
IHL-700WB-3072-701-BL-M	30"D x 72"W x 36.00"H	Hardwood/Maple - 1.75"H
IHL-700WB-3072-701-BL-SS	30"D x 72"W x 36.25"H	Stainless Steel - 2"H
IHL-700WB-3072-701-BL-LE	30"D x 72"W x 35.50"H	ESD Laminate - 1.25"H
IHL-700WB-3072-701-BL-L	30"D x 72"W x 35.50"H	Plastic Laminate - 1.25"H

Worksurface Types:



Painted Steel



Hardwood/Maple



Stainless Steel



ESD Laminate



Plastic Laminate w/ Armor Edge



- Worksurface Area: 72"W x 30"D
- LH Door Cabinet: 18"W x 28"D
- Single Door w/ Adjustable Shelf
- Rear Support Stringer
- RH Door Cabinet: 18"W x 28"D
- Single Door w/ Adjustable Shelf

- Worksurface Area: 72"W x 30"D
- LH 4 Drawer Cabinet: 18"W x 28"D
- Drawer No's.: 75 / 125 / 200 / 300
- Rear Support Stringer
- RH Door Cabinet: 18"W x 28"D
- Single Door w/ Adjustable Shelf

Part #	Overall Size	Top Description
IHL-700WB-3072-001-001-S	30"D x 72"W x 36.25"H	Painted Steel - 2"H
IHL-700WB-3072-001-001-M	30"D x 72"W x 36.00"H	Hardwood/Maple - 1.75"H
IHL-700WB-3072-001-001-SS	30"D x 72"W x 36.25"H	Stainless Steel - 2"H
IHL-700WB-3072-001-001-LE	30"D x 72"W x 35.50"H	ESD Laminate - 1.25"H
IHL-700WB-3072-001-001-L	30"D x 72"W x 35.50"H	Plastic Laminate - 1.25"H

Part #	Overall Size	Top Description
IHL-700WB-3072-401-001-S	30"D x 72"W x 36.25"H	Painted Steel - 2"H
IHL-700WB-3072-401-001-M	30"D x 72"W x 36.00"H	Hardwood/Maple - 1.75"H
IHL-700WB-3072-401-001-SS	30"D x 72"W x 36.25"H	Stainless Steel - 2"H
IHL-700WB-3072-401-001-LE	30"D x 72"W x 35.50"H	ESD Laminate - 1.25"H
IHL-700WB-3072-401-001-L	30"D x 72"W x 35.50"H	Plastic Laminate - 1.25"H



- Worksurface Area: 72"W x 30"D
- LH 4 Drawer Cabinet: 18"W x 28"D
- Drawer No's.: 75 / 125 / 200 / 300
- Rear Support Stringer
- RH 4 Drawer Cabinet: 18"W x 28"D
- Drawer No's.: 75 / 125 / 200 / 300

- Worksurface Area: 72"W x 30"D
- LH 7 Drawer Cabinet: 18"W x 28"D
- Drawer No's.: 75(2) / 100(4) / 150
- Rear Support Stringer
- RH Door Cabinet: 18"W x 28"D
- Single Door w/ Adjustable Shelf

Part #	Overall Size	Top Description
IHL-700WB-3072-401-401-S	30"D x 72"W x 36.25"H	Painted Steel - 2"H
IHL-700WB-3072-401-401-M	30"D x 72"W x 36.00"H	Hardwood/Maple - 1.75"H
IHL-700WB-3072-401-401-SS	30"D x 72"W x 36.25"H	Stainless Steel - 2"H
IHL-700WB-3072-401-401-LE	30"D x 72"W x 35.50"H	ESD Laminate - 1.25"H
IHL-700WB-3072-401-401-L	30"D x 72"W x 35.50"H	Plastic Laminate - 1.25"H

Part #	Overall Size	Top Description
IHL-700WB-3072-701-001-S	30"D x 72"W x 36.25"H	Painted Steel - 2"H
IHL-700WB-3072-701-001-M	30"D x 72"W x 36.00"H	Hardwood/Maple - 1.75"H
IHL-700WB-3072-701-001-SS	30"D x 72"W x 36.25"H	Stainless Steel - 2"H
IHL-700WB-3072-701-001-LE	30"D x 72"W x 35.50"H	ESD Laminate - 1.25"H
IHL-700WB-3072-701-001-L	30"D x 72"W x 35.50"H	Plastic Laminate - 1.25"H

Worksurface Types:



Painted Steel



Hardwood/Maple



Stainless Steel



ESD Laminate



Plastic Laminate w/ Armor Edge



- Worksurface Area: 72"W x 30"D
- LH 7 Drawer Cabinet: 18"W x 28"D
- Drawer No's.: 75(2) / 100(4) / 150
- Rear Support Stringer
- RH 4 Drawer Cabinet: 18"W x 28"D
- Drawer No's.: 75 / 125 / 200 / 300

- Worksurface Area: 72"W x 30"D
- LH 7 Drawer Cabinet: 18"W x 28"D
- Drawer No's.: 75(2) / 100(4) / 150
- Rear Support Stringer
- RH 7 Drawer Cabinet: 18"W x 28"D
- Drawer No's.: 75(2) / 100(4) / 150

Part #	Overall Size	Top Description
IHL-700WB-3072-701-401-S	30"D x 72"W x 36.25"H	Painted Steel - 2"H
IHL-700WB-3072-701-401-M	30"D x 72"W x 36.00"H	Hardwood/Maple - 1.75"H
IHL-700WB-3072-701-401-SS	30"D x 72"W x 36.25"H	Stainless Steel - 2"H
IHL-700WB-3072-701-401-LE	30"D x 72"W x 35.50"H	ESD Laminate - 1.25"H
IHL-700WB-3072-701-401-L	30"D x 72"W x 35.50"H	Plastic Laminate - 1.25"H

Part #	Overall Size	Top Description
IHL-700WB-3072-701-701-S	30"D x 72"W x 36.25"H	Painted Steel - 2"H
IHL-700WB-3072-701-701-M	30"D x 72"W x 36.00"H	Hardwood/Maple - 1.75"H
IHL-700WB-3072-701-701-SS	30"D x 72"W x 36.25"H	Stainless Steel - 2"H
IHL-700WB-3072-701-701-LE	30"D x 72"W x 35.50"H	ESD Laminate - 1.25"H
IHL-700WB-3072-701-701-L	30"D x 72"W x 35.50"H	Plastic Laminate - 1.25"H



The IHL Series Pro, Duel, & Solo lines of tool boxes are built using heavier gauge steel, higher capacity drawers, and packed with features that are setting the standard on what is expected in mobile tool storage by automotive and industrial professionals.

Cabinets feature 16 gauge steel welded construction. Drawers fully extend on 250 lb. ball bearing drawer glides that ensure you get maximum usability from every drawer. The contents of your drawers and cabinets remain secure with a keyed cylinder style lock. Drawers feature full width extruded aluminum handles with an integrated lift latch system that keep drawers closed while moving around the shop. To open the drawer you simply lift up on the tilting handle and pull open. Door cabinets feature doors mounted on heavy duty hinges and come standard with one pull out shelf inside. The handle also features grooves for inserting labels for better organization and easy identification of drawer contents. Moving the cabinet is a breeze with heavy duty 6" casters and the dual push/pull knobby handles mounted to the side of the box.

The PRO series tool boxes add the convenience of four power and two USB outlets on the side of the box. Perfect for charging cordless tool batteries, tablets, phones, or other rechargeable diagnostic devices.

IHL Series Mobile Tool Boxes Standard Features:

- All Welded Construction
- 16 Gauge Steel
- 250lb. Ball Bearing Drawer Glides
- Fully Extending Drawers
- 6" Casters (2-Swivel / Locking & 2-Fixed)
- Lift Latch Drawer System
- Drawer Width Extruded Aluminium Handles
- Ergonomic Push / Pull Handles
- Door Cabinets Include 1 Pull-Out Shelf



Optional Worksurfaces:

Turn your tool box into a mobile workbench with the addition of one of our worksurfaces. See page 135 for info.

- Top Chest Tool Box
- 16 Gauge Welded Steel
- 250lb. Ball Bearing Drawer Glides
- Fully Extending Drawers
- Top Lid Lift/Support Shocks
- Fits PRO & DUO 28"D Tool Boxes
- Extruded Aluminum Handles
- Lift Latch Drawer System
- Charging Apron in Top Compartment
- Top Compartment Rubber Mat

Part #	Overall Size	Drawers (Usable Heights)
IHLTB-500-TC-501-48	48"W x 28"D x 24"H	Top Compartment: 7.5"H Interior
IHLTB-500-TC-501-54	54"W x 28"D x 24"H	LH: (2) 2" / (1) 5"
IHLTB-500-TC-501-60	60"W x 28"D x 24"H	RH: (1) 2" / (2) 3"



- 7 Drawer / 1 Door Tool Storage Box
- 16 Gauge Welded Steel
- 250lb. Ball Bearing Drawer Glides
- Fully Extending Drawers
- 6" Casters (2 Swivel/Locking - 2 Fixed)
- Extruded Aluminum Handles
- Lift Latch Drawer System
- 4 Power / 2 USB Side Outlets

- 8 Drawer / 1 Door Tool Storage Box
- 16 Gauge Welded Steel
- 250lb. Ball Bearing Drawer Glides
- Fully Extending Drawers
- 6" Casters (2 Swivel/Locking - 2 Fixed)
- Extruded Aluminum Handles
- Lift Latch Drawer System
- 4 Power / 2 USB Side Outlets

Part #	Overall Size	Drawers (Usable Heights)
IHLTB-750-PRO-7-1D-48	48"W x 28"D x 41.75"H	Top Full Width: (1) 5"
IHLTB-750-PRO-7-1D-54	54"W x 28"D x 41.75"H	LH: (1) 2" / (1) 3" / (1) 6" / (1) 9.2"
IHLTB-750-PRO-7-1D-60	60"W x 28"D x 41.75"H	RH: (2) 2" / (1) 18" Door w/Shelf

Part #	Overall Size	Drawers (Usable Heights)
IHLTB-750-PRO-8-1D-48	48"W x 28"D x 41.75"H	Top Full Width: (1) 5"
IHLTB-750-PRO-8-1D-54	54"W x 28"D x 41.75"H	LH: (2) 2" / (3) 3" / (1) 5"
IHLTB-750-PRO-8-1D-60	60"W x 28"D x 41.75"H	RH: (1) 5" / (1) 18" Door w/Shelf



- 10 Drawer Tool Storage Box
- 16 Gauge Welded Steel
- 250lb. Ball Bearing Drawer Glides
- Fully Extending Drawers
- 6" Casters (2 Swivel/Locking - 2 Fixed)
- Extruded Aluminum Handles
- Lift Latch Drawer System
- 4 Power / 2 USB Side Outlets

- 12 Drawer Tool Storage Box
- 16 Gauge Welded Steel
- 250lb. Ball Bearing Drawer Glides
- Fully Extending Drawers
- 6" Casters (2 Swivel/Locking - 2 Fixed)
- Extruded Aluminum Handles
- Lift Latch Drawer System
- 4 Power / 2 USB Side Outlets

Part #	Overall Size	Drawers (Usable Heights)
IHLTB-750-PRO-10-1D-48	48"W x 28"D x 41.75"H	Top Full Width: (1) 5"
IHLTB-750-PRO-10-1D-54	54"W x 28"D x 41.75"H	LH: (2) 2" / (1) 3" / (1) 5" / (1) 7.1"
IHLTB-750-PRO-10-1D-60	60"W x 28"D x 41.75"H	RH: (1) 2" / (1) 3" / (1) 4" / (1) 11.2"

Part #	Overall Size	Drawers (Usable Heights)
IHLTB-750-PRO-12-1D-48	48"W x 28"D x 41.75"H	Top Full Width: (1) 5"
IHLTB-750-PRO-12-1D-54	54"W x 28"D x 41.75"H	LH: (2) 2" / (3) 3" / (1) 5"
IHLTB-750-PRO-12-1D-60	60"W x 28"D x 41.75"H	RH: (2) 2" / (1) 3" / (1) 5" / (1) 7.1"



- 10 Drawer / 1 Door Tool Storage Box
- 16 Gauge Welded Steel
- 250lb. Ball Bearing Drawer Glides
- Fully Extending Drawers
- 6" Casters (2 Swivel/Locking - 2 Fixed)
- Extruded Aluminum Handles
- Lift Latch Drawer System
- Push/Pull Handles

- 10 Drawer / 1 Door Tool Storage Box
- 16 Gauge Welded Steel
- 250lb. Ball Bearing Drawer Glides
- Fully Extending Drawers
- 6" Casters (2 Swivel/Locking - 2 Fixed)
- Extruded Aluminum Handles
- Lift Latch Drawer System
- Push/Pull Handles

Part #	Overall Size	Drawers (Usable Heights)
IHLTB-750-DUO-801-2150D-48	48"W x 28"D x 41.75"H	LH: (4) 2" / (3) 3" / (1) 5"
IHLTB-750-DUO-801-2150D-54	54"W x 28"D x 41.75"H	RH: (2) 5" / (1) 18" Door
IHLTB-750-DUO-801-2150D-60	60"W x 28"D x 41.75"H	

Part #	Overall Size	Drawers (Usable Heights)
IHLTB-750-DUO-601-475D-48	48"W x 28"D x 41.75"H	LH: (2) 2" / (1) 3" / (2) 5" / (1) 7.1"
IHLTB-750-DUO-601-475D-54	54"W x 28"D x 41.75"H	RH: (4) 2" / (1) 18" Door
IHLTB-750-DUO-601-475D-60	60"W x 28"D x 41.75"H	



- 12 Drawer Tool Storage Box
- 16 Gauge Welded Steel
- 250lb. Ball Bearing Drawer Glides
- Fully Extending Drawers
- 6" Casters (2 Swivel/Locking - 2 Fixed)
- Extruded Aluminum Handles
- Lift Latch Drawer System
- Push/Pull Handles

- 12 Drawer Tool Storage Box
- 16 Gauge Welded Steel
- 250lb. Ball Bearing Drawer Glides
- Fully Extending Drawers
- 6" Casters (2 Swivel/Locking - 2 Fixed)
- Extruded Aluminum Handles
- Lift Latch Drawer System
- Push/Pull Handles

Part #	Overall Size	Drawers (Usable Heights)
IHLTB-750-DUO-701-501-48	48"W x 28"D x 41.75"H	LH: (4) 2" / (1) 3" / (1) 5" / (1) 7.1"
IHLTB-750-DUO-701-501-54	54"W x 28"D x 41.75"H	RH: (1) 2" / (1) 3" / (1) 4"
IHLTB-750-DUO-701-501-60	60"W x 28"D x 41.75"H	(1) 5" / (1) 11.2"

Part #	Overall Size	Drawers (Usable Heights)
IHLTB-750-DUO-502-701-48	48"W x 28"D x 41.75"H	LH: (2) 3" / (2) 5" / (1) 9.2"
IHLTB-750-DUO-502-701-54	54"W x 28"D x 41.75"H	RH: (4) 2" / (1) 3" / (1) 5" / (1) 7.1"
IHLTB-750-DUO-502-701-60	60"W x 28"D x 41.75"H	



- 4 Drawer Tool Storage Cabinet
- 16 Gauge Welded Steel
- 250lb. Ball Bearing Drawer Glides
- Fully Extending Drawers
- 6" Casters (2 Swivel/Locking - 2 Fixed)
- Extruded Aluminum Handles
- Lift Latch Drawer System
- Push/Pull Handles

- 5 Drawer Tool Storage Cabinet
- 16 Gauge Welded Steel
- 250lb. Ball Bearing Drawer Glides
- Fully Extending Drawers
- 6" Casters (2 Swivel/Locking - 2 Fixed)
- Extruded Aluminum Handles
- Lift Latch Drawer System
- Push/Pull Handles

Part #	Overall Size	Drawers (Usable Heights)
IHLTB-750-SOLO-401-30	30"W x 24"D x 41.75"H	(2) 5" / (1) 7.1" / (1) 9.2"
IHLTB-750-SOLO-401-36	36"W x 24"D x 41.75"H	
IHLTB-750-SOLO-401-48	48"W x 24"D x 41.75"H	

Part #	Overall Size	Drawers (Usable Heights)
IHLTB-750-SOLO-502-30	30"W x 24"D x 41.75"H	(2) 3" / (2) 5" / (1) 9.2"
IHLTB-750-SOLO-502-36	36"W x 24"D x 41.75"H	
IHLTB-750-SOLO-502-48	48"W x 24"D x 41.75"H	



- 6 Drawer Tool Storage Cabinet
- 16 Gauge Welded Steel
- 250lb. Ball Bearing Drawer Glides
- Fully Extending Drawers
- 6" Casters (2 Swivel/Locking - 2 Fixed)
- Extruded Aluminum Handles
- Lift Latch Drawer System
- Push/Pull Handles

- 7 Drawer Tool Storage Cabinet
- 16 Gauge Welded Steel
- 250lb. Ball Bearing Drawer Glides
- Fully Extending Drawers
- 6" Casters (2 Swivel/Locking - 2 Fixed)
- Extruded Aluminum Handles
- Lift Latch Drawer System
- Push/Pull Handles

Part #	Overall Size	Drawers (Usable Heights)
IHLTB-750-SOLO-601-30	30"W x 24"D x 41.75"H	(2) 2" / (1) 3" / (2) 5" / (1) 7.1"
IHLTB-750-SOLO-601-36	36"W x 24"D x 41.75"H	
IHLTB-750-SOLO-601-48	48"W x 24"D x 41.75"H	

Part #	Overall Size	Drawers (Usable Heights)
IHLTB-750-SOLO-701-30	30"W x 24"D x 41.75"H	(4) 2" / (1) 3" / (1) 5" / (1) 7.1"
IHLTB-750-SOLO-701-36	36"W x 24"D x 41.75"H	
IHLTB-750-SOLO-701-48	48"W x 24"D x 41.75"H	

Our Dura-Tech modular cabinets and work stations are of the heaviest constructed metal casework cabinets available on the market. Dura-Tech base cabinets feature all welded case and frame construction. The outer shell is constructed from 16 gauge furniture grade steel utilizing all welded construction. The bases are equipped standard with a 4”H recessed riser base including floor leveler glides. Drawers feature full extension glides rated for a 125lb. capacity. The drawer and door facings are full inner and outer headers securely welded together. All drawer components are formed from 18 gauge furniture grade steel and have easy access recessed aluminum handles. Individual cylinder locks are keyed alike (standard). Available with keyed different, master keyed locks. All door bases feature an interior adjustable shelf and self closing concealed door hinges.

Cabinet Features:

- Cabinet shells are one piece side, back, and face frame.
- Solid top and bottom panels.
- Interior security lip around face frame helps prevent tampering with locks.
- All welded construction. No rivets or spot welded joints.
- 4”H 16 Ga. recessed toe kick is standard.
- Drawer and door component rails run full height of cabinet.
- Floor levelers recessed into riser base.



Standard Cabinet Dimensions

Available Heights

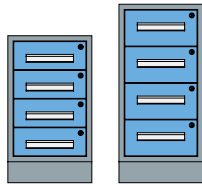

Desk 28”H Lab 34”H



Available Depths

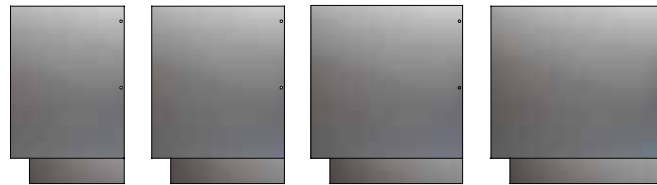

18”D 21”D 24”D 28”D

Available Widths

Desk and Lab Single Wide

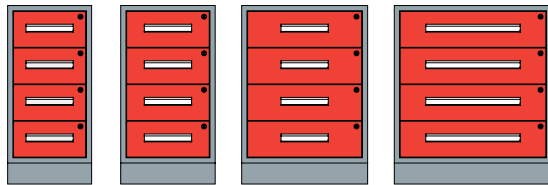

16”W 18”W 24”W 30”W

Available Widths

Desk and Lab Double Wide

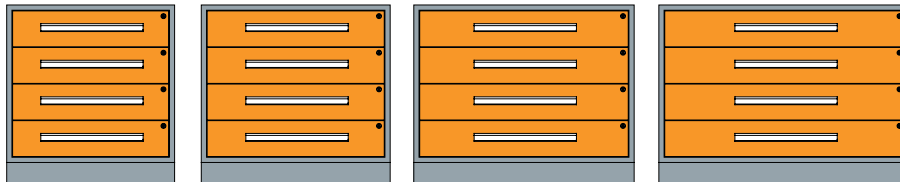

32”W 36”W 42”W 48”W

Dura-Tech Standard Drawer Detail

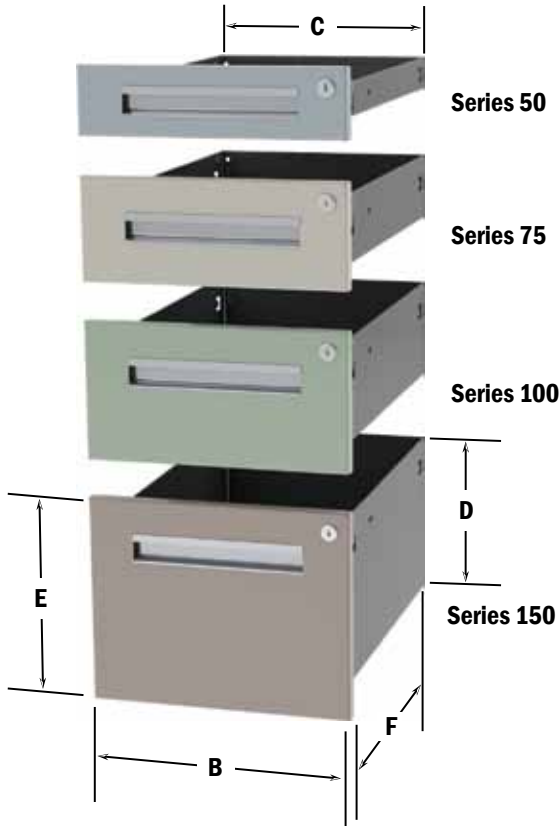

Drawer Box Dimension Chart						
	Cab Width	Face Width (B)	Box Width (C)	Box Height (D)	Face Height (E)	Drawer Depth (F)
Series 50	16"	13.75	12.25	DT=1.75 or DTL=2.40	DT=3.52 or DTL=4.52	Subtract 4" from cabinet depth.
	18"	15.75	14.25			
	24"	21.75	20.25			
	30"	27.75	26.25			
	32"	29.75	28.25			
	36"	33.75	32.25			
	42"	39.75	38.25			
Series 75	16"	13.75	12.25	DT=3.50 or DTL=5.00	DT=5.34 or DTL=6.84	Subtract 4" from cabinet depth.
	18"	15.75	14.25			
	24"	21.75	20.25			
	30"	27.75	26.25			
	32"	29.75	28.25			
	36"	33.75	32.25			
	42"	39.75	38.25			
Series 100	16"	13.75	12.25	DT=5.00 or DTL=7.00	DT=7.16 or DTL=9.16	Subtract 4" from cabinet depth.
	18"	15.75	14.25			
	24"	21.75	20.25			
	30"	27.75	26.25			
	32"	29.75	28.25			
	36"	33.75	32.25			
	42"	39.75	38.25			
Series 150	16"	13.75	12.25	DT=9.375 or DTL=11.75	DT=10.81 or DTL=13.81	Subtract 4" from cabinet depth.
	18"	15.75	14.25			
	24"	21.75	20.25			
	30"	27.75	26.25			
	32"	29.75	28.25			
	36"	33.75	32.25			
	42"	39.75	38.25			

Drawer/Door Component Features:

- Drawer boxes and doors are constructed of 18 gauge steel.
- Aluminum recessed door and drawer pulls are standard.
- Drawers feature inner and outer face panels.
- Chrome cylinder lock keyed alike. Optional keyed different and master keyed.
- Doors feature recessed/concealed hinges.
- Double door configurations have 3 point lock.
- Drawers mounted on 125 lb. full extension bearing glides.

Dura-Tech Standard Door Detail



Door Dimension Chart			
	Cab Width	Door Width (B)	Door Height (C)
Series 200	16"	13.75	DT=14.50 or DTL=18.50
	18"	15.75	
	24"	21.75	
	30"	27.75	
	32"	Double Doors @14.875 Double Doors @16.875 Double Doors @19.875 Double Doors @22.875	
	36"		
	42"		
Series 225	16"	13.75	DT=16.25 or DTL=20.75
	18"	15.75	
	24"	21.75	
	30"	27.75	
	32"	Double Doors @14.875 Double Doors @16.875 Double Doors @19.875 Double Doors @22.875	
	36"		
	42"		
Series 250	16"	13.75	DT=18.0 or DTL=23.00
	18"	15.75	
	24"	21.75	
	30"	27.75	
	32"	Double Doors @14.875 Double Doors @16.875 Double Doors @19.875 Double Doors @22.875	
	36"		
	42"		
Series 300	16"	13.75	DT=21.75 or DTL=27.75
	18"	15.75	
	24"	21.75	
	30"	27.75	
	32"	Double Doors @14.875 Double Doors @16.875 Double Doors @19.875 Double Doors @22.875	
	36"		
	42"		



	Depth	Height	6000	0400	0030	0002	1210
16" Wide	18"	DT (28"H) or DTL (34"H)	1618-6000	1618-0400	1618-0030	1618-0002	1618-1210
	21"		1621-6000	1621-0400	1621-0030	1621-0002	1621-1210
	24"		1624-6000	1624-0400	1624-0030	1624-0002	1624-1210
	28"		1628-6000	1628-0400	1628-0030	1628-0002	1628-1210
18" Wide	18"		1818-6000	1818-0400	1818-0030	1818-0002	1818-1210
	21"		1821-6000	1821-0400	1821-0030	1821-0002	1821-1210
	24"		1824-6000	1824-0400	1824-0030	1824-0002	1824-1210
	28"		1828-6000	1828-0400	1828-0030	1828-0002	1828-1210
24" Wide	18"		2418-6000	2418-0400	2418-0030	2418-0002	2418-1210
	21"		2421-6000	2421-0400	2421-0030	2421-0002	2421-1210
	24"		2424-6000	2424-0400	2424-0030	2424-0002	2424-1210
	28"		2428-6000	2428-0400	2428-0030	2428-0002	2428-1210
30" Wide	18"		3018-6000	3018-0400	3018-0030	3018-0002	3018-1210
	21"		3021-6000	3021-0400	3021-0030	3021-0002	3021-1210
	24"		3024-6000	3024-0400	3024-0030	3024-0002	3024-1210
	28"		3028-6000	3028-0400	3028-0030	3028-0002	3028-1210

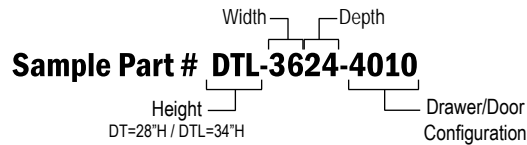

	Depth	Height	3200	3001	0100	0000 Single Shelf	2000
16" Wide	18"	DT (28"H) or DTL (34"H)	1618-3200	1618-3001	1618-0100	1618-0000	1618-2000
	21"		1621-3200	1621-3001	1621-0100	1621-0000	1621-2000
	24"		1624-3200	1624-3001	1624-0100	1624-0000	1624-2000
	28"		1628-3200	1628-3001	1628-0100	1628-0000	1628-2000
18" Wide	18"		1818-3200	1818-3001	1818-0100	1818-0000	1818-2000
	21"		1821-3200	1821-3001	1821-0100	1821-0000	1821-2000
	24"		1824-3200	1824-3001	1824-0100	1824-0000	1824-2000
	28"		1828-3200	1828-3001	1828-0100	1828-0000	1828-2000
24" Wide	18"		2418-3200	2418-3001	2418-0100	2418-0000	2418-2000
	21"		2421-3200	2421-3001	2421-0100	2421-0000	2421-2000
	24"		2424-3200	2424-3001	2424-0100	2424-0000	2424-2000
	28"		2428-3200	2428-3001	2428-0100	2428-0000	2428-2000
30" Wide	18"		3018-3200	3018-3001	3018-0100	3018-0000	3018-2000
	21"		3021-3200	3021-3001	3021-0100	3021-0000	3021-2000
	24"		3024-3200	3024-3001	3024-0100	3024-0000	3024-2000
	28"		3028-3200	3028-3001	3028-0100	3028-0000	3028-2000



	Depth	Height	0201	2020	4010	6000-W	0400-W
16" Wide	18"	DT (28"H) or DTL (34"H)	1618-0201	1618-2020	1618-4010	1618-6000-W	1618-0400-W
	21"		1621-0201	1621-2020	1621-4010	1621-6000-W	1621-0400-W
	24"		1624-0201	1624-2020	1624-4010	1624-6000-W	1624-0400-W
	28"		1628-0201	1628-2020	1628-4010	1628-6000-W	1628-0400-W
18" Wide	18"		1818-0201	1818-2020	1818-4010	1818-6000-W	1818-0400-W
	21"		1821-0201	1821-2020	1821-4010	1821-6000-W	1821-0400-W
	24"		1824-0201	1824-2020	1824-4010	1824-6000-W	1824-0400-W
	28"		1828-0201	1828-2020	1828-4010	1828-6000-W	1828-0400-W
24" Wide	18"		2418-0201	2418-2020	2418-4010	2418-6000-W	2418-0400-W
	21"		2421-0201	2421-2020	2421-4010	2421-6000-W	2421-0400-W
	24"		2424-0201	2424-2020	2424-4010	2424-6000-W	2424-0400-W
	28"		2428-0201	2428-2020	2428-4010	2428-6000-W	2428-0400-W
30" Wide	18"		3018-0201	3018-2020	3018-4010	3018-6000-W	3018-0400-W
	21"		3021-0201	3021-2020	3021-4010	3021-6000-W	3021-0400-W
	24"		3024-0201	3024-2020	3024-4010	3024-6000-W	3024-0400-W
	28"		3028-0201	3028-2020	3028-4010	3028-6000-W	3028-0400-W

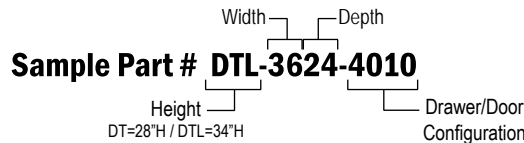

	Depth	Height	4010-W	0201-W	0100-W Single Shelf	1210-W	1000-W Single Shelf
16" Wide	18"	DT (28"H) or DTL (34"H)	1618-4010-W	1618-0201-W	1618-0100-W	1618-1210-W	1618-1000-W
	21"		1621-4010-W	1621-0201-W	1621-0100-W	1621-1210-W	1621-1000-W
	24"		1624-4010-W	1624-0201-W	1624-0100-W	1624-1210-W	1624-1000-W
	28"		1628-4010-W	1628-0201-W	1628-0100-W	1628-1210-W	1628-1000-W
18" Wide	18"		1818-4010-W	1818-0201-W	1818-0100-W	1818-1210-W	1818-1000-W
	21"		1821-4010-W	1821-0201-W	1821-0100-W	1821-1210-W	1821-1000-W
	24"		1824-4010-W	1824-0201-W	1824-0100-W	1824-1210-W	1824-1000-W
	28"		1828-4010-W	1828-0201-W	1828-0100-W	1828-1210-W	1828-1000-W
24" Wide	18"		2418-4010-W	2418-0201-W	2418-0100-W	2418-1210-W	2418-1000-W
	21"		2421-4010-W	2421-0201-W	2421-0100-W	2421-1210-W	2421-1000-W
	24"		2424-4010-W	2424-0201-W	2424-0100-W	2424-1210-W	2424-1000-W
	28"		2428-4010-W	2428-0201-W	2428-0100-W	2428-1210-W	2428-1000-W
30" Wide	18"		3018-4010-W	3018-0201-W	3018-0100-W	3018-1210-W	3018-1000-W
	21"		3021-4010-W	3021-0201-W	3021-0100-W	3021-1210-W	3021-1000-W
	24"		3024-4010-W	3024-0201-W	3024-0100-W	3024-1210-W	3024-1000-W
	28"		3028-4010-W	3028-0201-W	3028-0100-W	3028-1210-W	3028-1000-W



	Depth	Height	6000	0400	0030	0002
32" Wide	18"	DT (28"H) or DTL (34"H)	3218-6000	3218-0400	3218-0030	3218-0002
	21"		3221-6000	3221-0400	3221-0030	3221-0002
	24"		3224-6000	3224-0400	3224-0030	3224-0002
	28"		3228-6000	3228-0400	3228-0030	3228-0002
36" Wide	18"		3618-6000	3618-0400	3618-0030	3618-0002
	21"		3621-6000	3621-0400	3621-0030	3621-0002
	24"		3624-6000	3624-0400	3624-0030	3624-0002
	28"		3628-6000	3628-0400	3628-0030	3628-0002
42" Wide	18"		4218-6000	4218-0400	4218-0030	4218-0002
	21"		4221-6000	4221-0400	4221-0030	4221-0002
	24"		4224-6000	4224-0400	4224-0030	4224-0002
	28"		4228-6000	4228-0400	4228-0030	4228-0002
48" Wide	18"		4818-6000	4818-0400	4818-0030	4818-0002
	21"		4821-6000	4821-0400	4821-0030	4821-0002
	24"		4824-6000	4824-0400	4824-0030	4824-0002
	28"		4828-6000	4828-0400	4828-0030	4828-0002

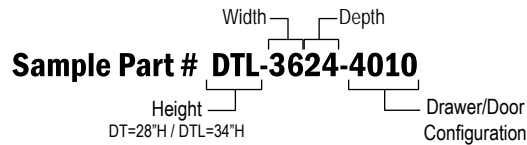

	Depth	Height	0000 Single Shelf	0201	3200	3001
32" Wide	18"	DT (28"H) or DTL (34"H)	3218-0000	3218-0201	3218-3200	3218-3001
	21"		3221-0000	3221-0201	3221-3200	3221-3001
	24"		3224-0000	3224-0201	3224-3200	3224-3001
	28"		3228-0000	3228-0201	3228-3200	3228-3001
36" Wide	18"		3618-0000	3618-0201	3618-3200	3618-3001
	21"		3621-0000	3621-0201	3621-3200	3621-3001
	24"		3624-0000	3624-0201	3624-3200	3624-3001
	28"		3628-0000	3628-0201	3628-3200	3628-3001
42" Wide	18"		4218-0000	4218-0201	4218-3200	4218-3001
	21"		4221-0000	4221-0201	4221-3200	4221-3001
	24"		4224-0000	4224-0201	4224-3200	4224-3001
	28"		4228-0000	4228-0201	4228-3200	4228-3001
48" Wide	18"		4818-0000	4818-0201	4818-3200	4818-3001
	21"		4821-0000	4821-0201	4821-3200	4821-3001
	24"		4824-0000	4824-0201	4824-3200	4824-3001
	28"		4828-0000	4828-0201	4828-3200	4828-3001



	Depth	Height	2000 Single Shelf	4010	1210	SNK Sink Base Cabinet
32" Wide	18"	DT (28"H) or DTL (34"H)	3218-2000	3218-4010	3218-1210	3218-SNK
	21"		3221-2000	3221-4010	3221-1210	3221-SNK
	24"		3224-2000	3224-4010	3224-1210	3224-SNK
	28"		3228-2000	3228-4010	3228-1210	3228-SNK
36" Wide	18"		3618-2000	3618-4010	3618-1210	3618-SNK
	21"		3621-2000	3621-4010	3621-1210	3621-SNK
	24"		3624-2000	3624-4010	3624-1210	3624-SNK
	28"		3628-2000	3628-4010	3628-1210	3628-SNK
42" Wide	18"		4218-2000	4218-4010	4218-1210	4218-SNK
	21"		4221-2000	4221-4010	4221-1210	4221-SNK
	24"		4224-2000	4224-4010	4224-1210	4224-SNK
	28"		4228-2000	4228-4010	4228-1210	4228-SNK
48" Wide	18"	4818-2000	4818-4010	4818-1210	4818-SNK	
	21"	4821-2000	4821-4010	4821-1210	4821-SNK	
	24"	4824-2000	4824-4010	4824-1210	4824-SNK	
	28"	4828-2000	4828-4010	4828-1210	4828-SNK	

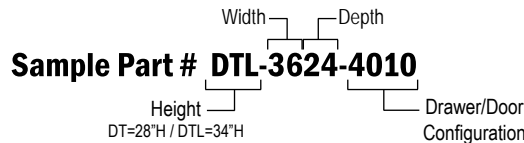

	Depth	Height	6000-W	0201-W	3001-W	0400-W
32" Wide	18"	DT (28"H) or DTL (34"H)	3218-6000-W	3218-0201-W	3218-3001-W	3218-0400-W
	21"		3221-6000-W	3221-0201-W	3221-3001-W	3221-0400-W
	24"		3224-6000-W	3224-0201-W	3224-3001-W	3224-0400-W
	28"		3228-6000-W	3228-0201-W	3228-3001-W	3228-0400-W
36" Wide	18"		3618-6000-W	3618-0201-W	3618-3001-W	3618-0400-W
	21"		3621-6000-W	3621-0201-W	3621-3001-W	3621-0400-W
	24"		3624-6000-W	3624-0201-W	3624-3001-W	3624-0400-W
	28"		3628-6000-W	3628-0201-W	3628-3001-W	3628-0400-W
42" Wide	18"		4218-6000-W	4218-0201-W	4218-3001-W	4218-0400-W
	21"		4221-6000-W	4221-0201-W	4221-3001-W	4221-0400-W
	24"		4224-6000-W	4224-0201-W	4224-3001-W	4224-0400-W
	28"		4228-6000-W	4228-0201-W	4228-3001-W	4228-0400-W
48" Wide	18"	4818-6000-W	4818-0201-W	4818-3001-W	4818-0400-W	
	21"	4821-6000-W	4821-0201-W	4821-3001-W	4821-0400-W	
	24"	4824-6000-W	4824-0201-W	4824-3001-W	4824-0400-W	
	28"	4828-6000-W	4828-0201-W	4828-3001-W	4828-0400-W	

Tall Storage Cabinet Features:

- Drawer cabinets ship with independent locking drawers.
- Optional drawer interlock available. Call factory.
- Single padlock security bar available on drawer cabinet configurations. Call factory.
- Drawers mounted on 125 lb. full extension bearing glides.
- Drawers available with optional divider kits. See page 35.
- Some models require floor anchoring.



Width	Depth	0010	0020	0300	4000
24"	24"	WDT - 2424-0010-72__	WDT - 2424-0020-72__	WDT - 2424-0300-72__	WDT - 2424-4000-72__
	28"	WDT - 2428-0010-72__	WDT - 2428-0020-72__	WDT - 2428-0300-72__	WDT - 2428-4000-72__
32"	24"	WDT - 3224-0010-72__	WDT - 3224-0020-72__	WDT - 3224-0300-72__	WDT - 3224-4000-72__
	28"	WDT - 3228-0010-72__	WDT - 3228-0020-72__	WDT - 3228-0300-72__	WDT - 3228-4000-72__
36"	24"	WDT - 3624-0010-72__	WDT - 3624-0020-72__	WDT - 3624-0300-72__	WDT - 3624-4000-72__
	28"	WDT - 3628-0010-72__	WDT - 3628-0020-72__	WDT - 3628-0300-72__	WDT - 3628-4000-72__

Cabinet Height 72"

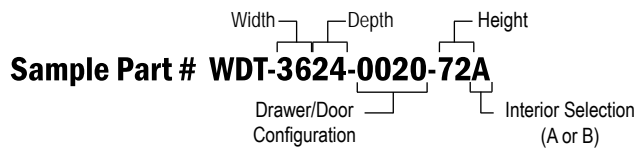

Two Interior Configurations to Choose From:

- Interior "A" or "B" is available for all sizes of the WDT-Series cabinets.
- Interior "A" = (3) Full width interior shelves.
- Interior "B" = Divided interior with (3) 1/2 width shelves and hanger bar.

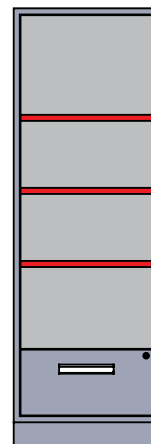

Interior "A"

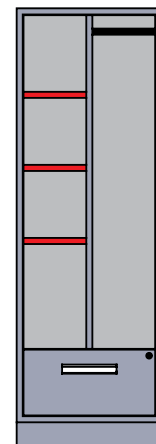

Interior "B"

Drawer Dividers:

Divider kits are available for all sizes of Dura-Tech drawers. The dividers keep parts of all sizes organized and readily available. To order please provide us with the divider kit selection, drawer number (see page 29), and the width & depth of the cabinet.

Note: Kits are designed for new cabinet orders, retrofitting to existing cabinets will require the purchase of a new drawers.

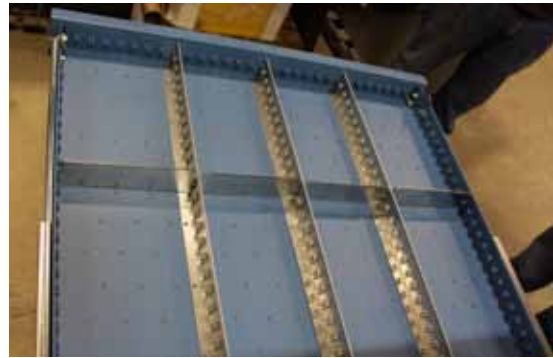

Divider Kit #: **DIV-10_4F5S-DT-150-3628**
 DT or DTL Width Depth
 Height Cabinet Drawer Number

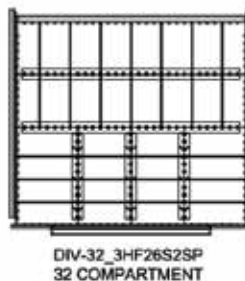
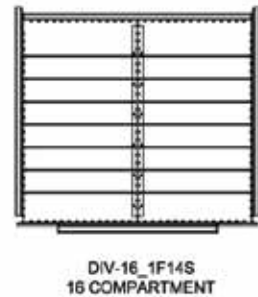
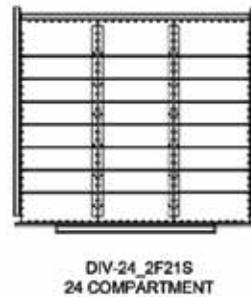
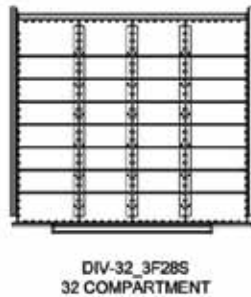
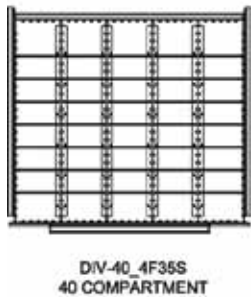
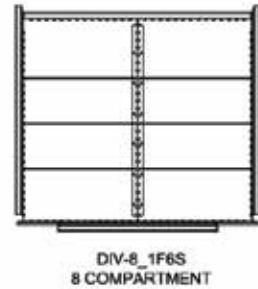
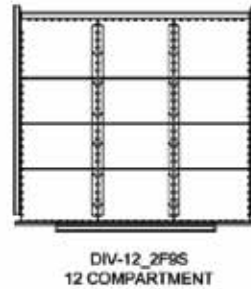
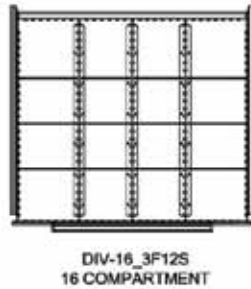
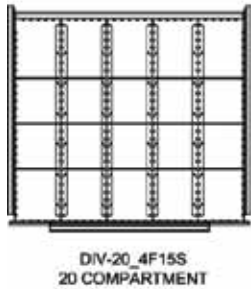
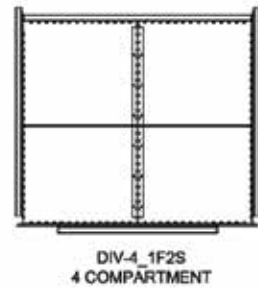
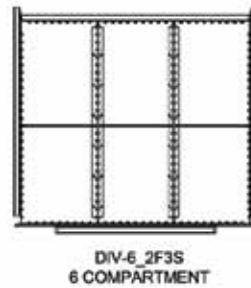
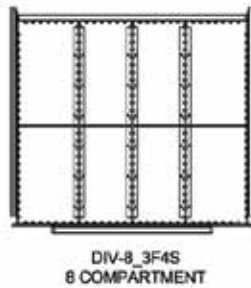
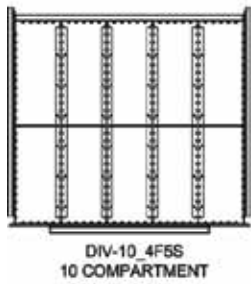

Our versatile Dura-Tech wall cabinets are ideal for overhead storing of tools and supplies. Available in a number of sizes and configurations, these cabinets are built to withstand use in the toughest environments. Our cabinets feature all welded construction from 16 and 18 gauge steel and a full face frame with welded seams. GMI incorporates top quality hardware components into all of our Dura-Tech cabinet products to ensure years of trouble-free service.

Standard Features:

- Concealed 105 Degree Door Hinges.
- Recessed Aluminum Handles.
- Three Point Cylinder Lock Keyed Alike.
- 16 Gauge Steel Adjustable Interior Shelves.
- All Welded Construction.



DTW-1236-3000 Wall Cabinet

Heavy duty recessed hinges are standard.



Secure multi-point lock mechanism. Cylinder lock keyed alike is standard.



Full Width Adjustable Shelves

Sturdy, all welded steel construction. All face seams are welded and ground smooth.



In Line Wall Cabinets

		Width	18" Tall	Shelves	24" Tall	Shelves	30" Tall	Shelves
Single Door	12" Deep	12"	DTW - 1212 - 1800	2	DTW - 1212 - 2400	3	DTW - 1212 - 3000	3
		15"	DTW - 1215 - 1800	2	DTW - 1215 - 2400	3	DTW - 1215 - 3000	3
		18"	DTW - 1218 - 1800	2	DTW - 1218 - 2400	3	DTW - 1218 - 3000	3
		21"	DTW - 1221 - 1800	2	DTW - 1221 - 2400	3	DTW - 1221 - 3000	3
Double Door	12" Deep	24"	DTW - 1224 - 1800	2	DTW - 1224 - 2400	3	DTW - 1224 - 3000	3
		27"	DTW - 1227 - 1800	2	DTW - 1227 - 2400	3	DTW - 1227 - 3000	3
		30"	DTW - 1230 - 1800	2	DTW - 1230 - 2400	3	DTW - 1230 - 3000	3
		32"	DTW - 1232 - 1800	2	DTW - 1232 - 2400	3	DTW - 1232 - 3000	3
		36"	DTW - 1236 - 1800	2	DTW - 1236 - 2400	3	DTW - 1236 - 3000	3
Single Door	18" Deep	12"	DTW - 1812 - 1800	2	DTW - 1812 - 2400	3	DTW - 1812 - 3000	3
		15"	DTW - 1815 - 1800	2	DTW - 1815 - 2400	3	DTW - 1815 - 3000	3
		18"	DTW - 1818 - 1800	2	DTW - 1818 - 2400	3	DTW - 1818 - 3000	3
		21"	DTW - 1821 - 1800	2	DTW - 1821 - 2400	3	DTW - 1821 - 3000	3
Double Door	18" Deep	24"	DTW - 1824 - 1800	2	DTW - 1824 - 2400	3	DTW - 1824 - 3000	3
		27"	DTW - 1827 - 1800	2	DTW - 1827 - 2400	3	DTW - 1827 - 3000	3
		30"	DTW - 1830 - 1800	2	DTW - 1830 - 2400	3	DTW - 1830 - 3000	3
		32"	DTW - 1832 - 1800	2	DTW - 1832 - 2400	3	DTW - 1832 - 3000	3
		36"	DTW - 1836 - 1800	2	DTW - 1836 - 2400	3	DTW - 1836 - 3000	3

Corner Wall Cabinets

		Width	18" Tall	Shelves	24" Tall	Shelves	30" Tall	Shelves
Single Door	12" Deep	24" Along Corner	DTWC - 1224 - 1800	2	DTWC - 1224 - 2400	3	DTWC - 1224 - 3000	3
Single Door	18" Deep	24" Along Corner	DTWC - 1824 - 1800	2	DTWC - 1824 - 2400	3	DTWC - 1824 - 3000	3

Typical corner installation using Dura-Tech base components, hardwood/maple tops, and standard front wall cabinets.





Clear View wall cabinets offer the same quality and construction as the standard Dura-Tech wall cabinets. The door fronts are fitted with a 3/16" thick polycarbonate clear panel to allow the cabinet contents to be easily viewed.

The standard cabinet configuration comes with adjustable shelves and three point cylinder style lock keyed alike.

		Width	18" Tall	Shelves	24" Tall	Shelves	30" Tall	Shelves
Single Door	12" Deep	12"	DTW - 1212 - 1800CV	2	DTW - 1212 - 2400CV	3	DTW - 1212 - 3000CV	3
		15"	DTW - 1215 - 1800CV	2	DTW - 1215 - 2400CV	3	DTW - 1215 - 3000CV	3
		18"	DTW - 1218 - 1800CV	2	DTW - 1218 - 2400CV	3	DTW - 1218 - 3000CV	3
		21"	DTW - 1221 - 1800CV	2	DTW - 1221 - 2400CV	3	DTW - 1221 - 3000CV	3
Double Door	12" Deep	24"	DTW - 1224 - 1800CV	2	DTW - 1224 - 2400CV	3	DTW - 1224 - 3000CV	3
		27"	DTW - 1227 - 1800CV	2	DTW - 1227 - 2400CV	3	DTW - 1227 - 3000CV	3
		30"	DTW - 1230 - 1800CV	2	DTW - 1230 - 2400CV	3	DTW - 1230 - 3000CV	3
		32"	DTW - 1232 - 1800CV	2	DTW - 1232 - 2400CV	3	DTW - 1232 - 3000CV	3
		36"	DTW - 1236 - 1800CV	2	DTW - 1236 - 2400CV	3	DTW - 1236 - 3000CV	3
Single Door	18" Deep	12"	DTW - 1812 - 1800CV	2	DTW - 1812 - 2400CV	3	DTW - 1812 - 3000CV	3
		15"	DTW - 1815 - 1800CV	2	DTW - 1815 - 2400CV	3	DTW - 1815 - 3000CV	3
		18"	DTW - 1818 - 1800CV	2	DTW - 1818 - 2400CV	3	DTW - 1818 - 3000CV	3
		21"	DTW - 1821 - 1800CV	2	DTW - 1821 - 2400CV	3	DTW - 1821 - 3000CV	3
Double Door	18" Deep	24"	DTW - 1824 - 1800CV	2	DTW - 1824 - 2400CV	3	DTW - 1824 - 3000CV	3
		27"	DTW - 1827 - 1800CV	2	DTW - 1827 - 2400CV	3	DTW - 1827 - 3000CV	3
		30"	DTW - 1830 - 1800CV	2	DTW - 1830 - 2400CV	3	DTW - 1830 - 3000CV	3
		32"	DTW - 1832 - 1800CV	2	DTW - 1832 - 2400CV	3	DTW - 1832 - 3000CV	3
		36"	DTW - 1836 - 1800CV	2	DTW - 1836 - 2400CV	3	DTW - 1836 - 3000CV	3

Tool Panel Option

The optional tool panels make storage, retrieval, and inventory of tools and supplies easier. Standard 1/4" fiber pegboard panels are fitted to support rails on the rear of the cabinet interior. Shelves may be used or removed as shown.

Order hook kits separately to configure the layout to fit your application. Tool panel hook kits sold separately.



Tools not Included.

Add (-PB) to above part numbers for tool panel option.

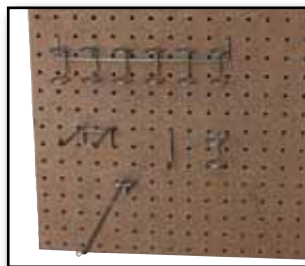

Peg Board Tool Hook Kit

- 200 piece assorted tool hook kit that includes:
- 50 - small "J" hooks
 - 50 - medium "J" hooks
 - 25 - 4" straight hooks
 - 25 - 2" straight hooks
 - 20 - single loop hooks
 - 20 - angled hooks
 - 05 - loop racks
 - 05 - hook racks

Part #	Description
PEG-200	200 Piece Hook Kit

GMI manufactures a complete line of stainless steel cabinets. We utilize the same fabrication and construction methods as our Dura-Tech line of wall and base cabinets. Our stainless cabinets are available in all the standard Dura-Tech cabinet configurations. Please contact a GMI representative for complete details on our stainless steel cabinet line.

Standard Features:

- Concealed 105 degree door hinges.
- Recessed aluminum handles.
- Cylinder locks keyed alike.
- 16 gauge stainless steel outer shell.
- 18 gauge stainless steel interior components.
- All welded construction.



Standard Recessed Door Hinge.

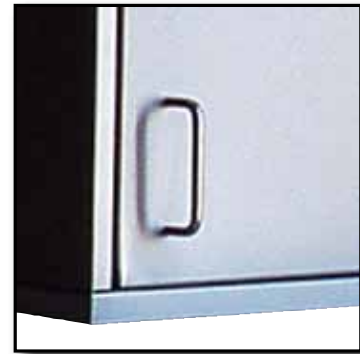

Optional Chrome Loop Handle.

Ordering Instructions:

To order our Dura-Tech Line of cabinets in durable Stainless Steel add .SS after any of our standard part numbers listed. See the sample part number below for an example.

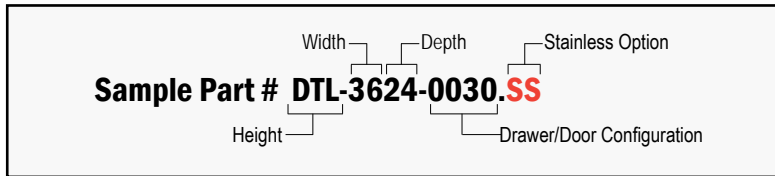

We've taken our most popular Dura-Tech work bench configurations and made ordering easy. Simply select the base style, length, and height of the workstation that best fits your needs and order with one part number for the complete configuration.

The Dura-Tech series of work stations are a perfect choice for electronics, manufacturing, science, and industrial assembly areas.

Dura-Tech pre-engineered work stations are equipped with the following standard options:

- 30"D hardwood/maple work surfaces.
- 12"D hardwood/maple upper shelves.
- 16"W x 24"D base cabinets.
- 3-1/2"W leg pedestals.
- 16"H powered rear shelf risers.
- 18"H lower modesty panels.
- 29-3/4"H "desk" height stations.
- 34-3/4"H "lab" height stations.
- Full width 4" x 4" wire management tray.
- 3.25" diameter hole grommets in work surface.

For additional accessories please see pages 47 & 136-139.



DT-6GG-Z Work Station



DT-6-GA Work Station

Pre-Engineered work stations are equipped with a 4" x 4" full width wire management tray.



Dura-Tech cabinets feature full extension ball bearing drawer glides and individual drawer locks.



Door bases are equipped with one adjustable shelf and feature heavy duty concealed door hinges.





- Top: Solid 1 3/4" Hardwood/Maple
- Left: Leg Pedestal
- Right: R.H. Single Door Base
- Lower Modesty Panel
- Wire Tray
- (1) 3.25" Grommet



- Top: Solid 1 3/4" Hardwood/Maple
- Left: Leg Pedestal
- Right: Six Drawer Base
- Lower Modesty Panel
- Wire Tray
- (1) 3.25" Grommet

Part #	Size	Description
DT-5AJ	30"D x 60"W x 29.75"H	5' Desk Height Work Station
DT-6AJ	30"D x 72"W x 29.75"H	6' Desk Height Work Station
DT-7AJ	30"D x 84"W x 29.75"H	7' Desk Height Work Station
DT-8AJ	30"D x 96"W x 29.75"H	8' Desk Height Work Station
DTL-5AJ	30"D x 60"W x 35.75"H	5' Lab Height Work Station
DTL-6AJ	30"D x 72"W x 35.75"H	6' Lab Height Work Station
DTL-7AJ	30"D x 84"W x 35.75"H	7' Lab Height Work Station
DTL-8AJ	30"D x 96"W x 35.75"H	8' Lab Height Work Station

Part #	Size	Description
DT-5AC	30"D x 60"W x 29.75"H	5' Desk Height Work Station
DT-6AC	30"D x 72"W x 29.75"H	6' Desk Height Work Station
DT-7AC	30"D x 84"W x 29.75"H	7' Desk Height Work Station
DT-8AC	30"D x 96"W x 29.75"H	8' Desk Height Work Station
DTL-5AC	30"D x 60"W x 35.75"H	5' Lab Height Work Station
DTL-6AC	30"D x 72"W x 35.75"H	6' Lab Height Work Station
DTL-7AC	30"D x 84"W x 35.75"H	7' Lab Height Work Station
DTL-8AC	30"D x 96"W x 35.75"H	8' Lab Height Work Station



- Top: Solid 1 3/4" Hardwood/Maple
- Left: Leg Pedestal
- Right: Four Drawer Base
- Lower Modesty Panel
- Wire Tray
- (1) 3.25" Grommet



- Top: Solid 1 3/4" Hardwood/Maple
- Left: Leg Pedestal
- Right: Two Drawer Base
- Lower Modesty Panel
- Wire Tray
- (1) 3.25" Grommet

Part #	Size	Description
DT-5AD	30"D x 60"W x 29.75"H	5' Desk Height Work Station
DT-6AD	30"D x 72"W x 29.75"H	6' Desk Height Work Station
DT-7AD	30"D x 84"W x 29.75"H	7' Desk Height Work Station
DT-8AD	30"D x 96"W x 29.75"H	8' Desk Height Work Station
DTL-5AD	30"D x 60"W x 35.75"H	5' Lab Height Work Station
DTL-6AD	30"D x 72"W x 35.75"H	6' Lab Height Work Station
DTL-7AD	30"D x 84"W x 35.75"H	7' Lab Height Work Station
DTL-8AD	30"D x 96"W x 35.75"H	8' Lab Height Work Station

Part #	Size	Description
DT-5AF	30"D x 60"W x 29.75"H	5' Desk Height Work Station
DT-6AF	30"D x 72"W x 29.75"H	6' Desk Height Work Station
DT-7AF	30"D x 84"W x 29.75"H	7' Desk Height Work Station
DT-8AF	30"D x 96"W x 29.75"H	8' Desk Height Work Station
DTL-5AF	30"D x 60"W x 35.75"H	5' Lab Height Work Station
DTL-6AF	30"D x 72"W x 35.75"H	6' Lab Height Work Station
DTL-7AF	30"D x 84"W x 35.75"H	7' Lab Height Work Station
DTL-8AF	30"D x 96"W x 35.75"H	8' Lab Height Work Station



- Top: Solid 1 3/4" Hardwood/Maple
- Left: Leg Pedestal
- Right: Three Drawer Base
- Lower Modesty Panel
- Wire Tray
- (1) 3.25" Grommet



- Top: Solid 1 3/4" Hardwood/Maple
- Left: Leg Pedestal
- Right: Five Drawer Base
- Lower Modesty Panel
- Wire Tray
- (1) 3.25" Grommet

Part #	Size	Description
DT-5AE	30"D x 60"W x 29.75"H	5' Desk Height Work Station
DT-6AE	30"D x 72"W x 29.75"H	6' Desk Height Work Station
DT-7AE	30"D x 84"W x 29.75"H	7' Desk Height Work Station
DT-8AE	30"D x 96"W x 29.75"H	8' Desk Height Work Station
DTL-5AE	30"D x 60"W x 35.75"H	5' Lab Height Work Station
DTL-6AE	30"D x 72"W x 35.75"H	6' Lab Height Work Station
DTL-7AE	30"D x 84"W x 35.75"H	7' Lab Height Work Station
DTL-8AE	30"D x 96"W x 35.75"H	8' Lab Height Work Station

Part #	Size	Description
DT-5AS	30"D x 60"W x 29.75"H	5' Desk Height Work Station
DT-6AS	30"D x 72"W x 29.75"H	6' Desk Height Work Station
DT-7AS	30"D x 84"W x 29.75"H	7' Desk Height Work Station
DT-8AS	30"D x 96"W x 29.75"H	8' Desk Height Work Station
DTL-5AS	30"D x 60"W x 35.75"H	5' Lab Height Work Station
DTL-6AS	30"D x 72"W x 35.75"H	6' Lab Height Work Station
DTL-7AS	30"D x 84"W x 35.75"H	7' Lab Height Work Station
DTL-8AS	30"D x 96"W x 35.75"H	8' Lab Height Work Station



- Top: Solid 1 3/4" Hardwood/Maple
- Left: Leg Pedestal
- Right: Two Box/File Drawer Base
- Lower Modesty Panel
- Wire Tray
- (1) 3.25" Grommet



- Top: Solid 1 3/4" Hardwood/Maple
- Left: Leg Pedestal
- Right: Single Drawer/Door Base
- Lower Modesty Panel
- Wire Tray
- (1) 3.25" Grommet

Part #	Size	Description
DT-5AG	30"D x 60"W x 29.75"H	5' Desk Height Work Station
DT-6AG	30"D x 72"W x 29.75"H	6' Desk Height Work Station
DT-7AG	30"D x 84"W x 29.75"H	7' Desk Height Work Station
DT-8AG	30"D x 96"W x 29.75"H	8' Desk Height Work Station
DTL-5AG	30"D x 60"W x 35.75"H	5' Lab Height Work Station
DTL-6AG	30"D x 72"W x 35.75"H	6' Lab Height Work Station
DTL-7AG	30"D x 84"W x 35.75"H	7' Lab Height Work Station
DTL-8AG	30"D x 96"W x 35.75"H	8' Lab Height Work Station

Part #	Size	Description
DT-5AK	30"D x 60"W x 29.75"H	5' Desk Height Work Station
DT-6AK	30"D x 72"W x 29.75"H	6' Desk Height Work Station
DT-7AK	30"D x 84"W x 29.75"H	7' Desk Height Work Station
DT-8AK	30"D x 96"W x 29.75"H	8' Desk Height Work Station
DTL-5AK	30"D x 60"W x 35.75"H	5' Lab Height Work Station
DTL-6AK	30"D x 72"W x 35.75"H	6' Lab Height Work Station
DTL-7AK	30"D x 84"W x 35.75"H	7' Lab Height Work Station
DTL-8AK	30"D x 96"W x 35.75"H	8' Lab Height Work Station



- Top: Solid 1 3/4" Hardwood/Maple
- Left: L.H. Single Door Base
- Right: Two Drawer Base
- Lower Modesty Panel
- Wire Tray
- (1) 3.25" Grommet



- Top: Solid 1 3/4" Hardwood/Maple
- Left: L.H. Single Door Base
- Right: Single Door Base
- Lower Modesty Panel
- Wire Tray
- (1) 3.25" Grommet

Part #	Size	Description
DT-6JF	30"D x 72"W x 29.75"H	6' Desk Height Work Station
DT-7JF	30"D x 84"W x 29.75"H	7' Desk Height Work Station
DT-8JF	30"D x 96"W x 29.75"H	8' Desk Height Work Station
DTL-6JF	30"D x 72"W x 35.75"H	6' Lab Height Work Station
DTL-7JF	30"D x 84"W x 35.75"H	7' Lab Height Work Station
DTL-8JF	30"D x 96"W x 35.75"H	8' Lab Height Work Station

Part #	Size	Description
DT-6JJ	30"D x 72"W x 29.75"H	6' Desk Height Work Station
DT-7JJ	30"D x 84"W x 29.75"H	7' Desk Height Work Station
DT-8JJ	30"D x 96"W x 29.75"H	8' Desk Height Work Station
DTL-6JJ	30"D x 72"W x 35.75"H	6' Lab Height Work Station
DTL-7JJ	30"D x 84"W x 35.75"H	7' Lab Height Work Station
DTL-8JJ	30"D x 96"W x 35.75"H	8' Lab Height Work Station



- Top: Solid 1 3/4" Hardwood/Maple
- Left: L.H. Single Door Base
- Right: Four Drawer Base
- Lower Modesty Panel
- Wire Tray
- (1) 3.25" Grommet



- Top: Solid 1 3/4" Hardwood/Maple
- Left: L.H. Single Door Base
- Right: Six Drawer Base
- Lower Modesty Panel
- Wire Tray
- (1) 3.25" Grommet

Part #	Size	Description
DT-6JD	30"D x 72"W x 29.75"H	6' Desk Height Work Station
DT-7JD	30"D x 84"W x 29.75"H	7' Desk Height Work Station
DT-8JD	30"D x 96"W x 29.75"H	8' Desk Height Work Station
DTL-6JD	30"D x 72"W x 35.75"H	6' Lab Height Work Station
DTL-7JD	30"D x 84"W x 35.75"H	7' Lab Height Work Station
DTL-8JD	30"D x 96"W x 35.75"H	8' Lab Height Work Station

Part #	Size	Description
DT-6JC	30"D x 72"W x 29.75"H	6' Desk Height Work Station
DT-7JC	30"D x 84"W x 29.75"H	7' Desk Height Work Station
DT-8JC	30"D x 96"W x 29.75"H	8' Desk Height Work Station
DTL-6JC	30"D x 72"W x 35.75"H	6' Lab Height Work Station
DTL-7JC	30"D x 84"W x 35.75"H	7' Lab Height Work Station
DTL-8JC	30"D x 96"W x 35.75"H	8' Lab Height Work Station



- Top: Solid 1 3/4" Hardwood/Maple
- Left: Leg Pedestal
- Center: L.H. Single Door Base
- Right: Leg Pedestal
- Lower Modesty Panel
- Wire Tray

- Top: Solid 1 3/4" Hardwood/Maple
- Left: Leg Pedestal
- Center: Two Drawer Base
- Right: Leg Pedestal
- Lower Modesty Panel
- Wire Tray

Part #	Size	Description
DT-6AJA	30"D x 72"W x 29.75"H	6' Desk Height Work Station
DT-7AJA	30"D x 84"W x 29.75"H	7' Desk Height Work Station
DT-8AJA	30"D x 96"W x 29.75"H	8' Desk Height Work Station
DTL-6AJA	30"D x 72"W x 35.75"H	6' Lab Height Work Station
DTL-7AJA	30"D x 84"W x 35.75"H	7' Lab Height Work Station
DTL-8AJA	30"D x 96"W x 35.75"H	8' Lab Height Work Station

Part #	Size	Description
DT-6AFA	30"D x 72"W x 29.75"H	6' Desk Height Work Station
DT-7AFA	30"D x 84"W x 29.75"H	7' Desk Height Work Station
DT-8AFA	30"D x 96"W x 29.75"H	8' Desk Height Work Station
DTL-6AFA	30"D x 72"W x 35.75"H	6' Lab Height Work Station
DTL-7AFA	30"D x 84"W x 35.75"H	7' Lab Height Work Station
DTL-8AFA	30"D x 96"W x 35.75"H	8' Lab Height Work Station



- Top: Solid 1 3/4" Hardwood/Maple
- Left: Leg Pedestal
- Center: Four Drawer Base
- Right: Leg Pedestal
- Lower Modesty Panel
- Wire Tray

- Top: Solid 1 3/4" Hardwood/Maple
- Left: Leg Pedestal
- Center: Six Drawer Base
- Right: Leg Pedestal
- Lower Modesty Panel
- Wire Tray

Part #	Size	Description
DT-6ADA	30"D x 72"W x 29.75"H	6' Desk Height Work Station
DT-7ADA	30"D x 84"W x 29.75"H	7' Desk Height Work Station
DT-8ADA	30"D x 96"W x 29.75"H	8' Desk Height Work Station
DTL-6ADA	30"D x 72"W x 35.75"H	6' Lab Height Work Station
DTL-7ADA	30"D x 84"W x 35.75"H	7' Lab Height Work Station
DTL-8ADA	30"D x 96"W x 35.75"H	8' Lab Height Work Station

Part #	Size	Description
DT-6ACA	30"D x 72"W x 29.75"H	6' Desk Height Work Station
DT-7ACA	30"D x 84"W x 29.75"H	7' Desk Height Work Station
DT-8ACA	30"D x 96"W x 29.75"H	8' Desk Height Work Station
DTL-6ACA	30"D x 72"W x 35.75"H	6' Lab Height Work Station
DTL-7ACA	30"D x 84"W x 35.75"H	7' Lab Height Work Station
DTL-8ACA	30"D x 96"W x 35.75"H	8' Lab Height Work Station



- Top: Solid 1 3/4" Hardwood/Maple
- Left: Leg Pedestal
- Right: R.H. Single Door Base
- Lower Modesty Panel
- Two 16"H Powered Risers
- Shelf: 12"D x 1 3/4" Hardwood/Maple
- Wire Tray
- (1) 3.25" Grommet

Part #	Size	Description
DT-5AJ-Z	30"D x 60"W x 29.75"H	5' Desk Height Work Station
DT-6AJ-Z	30"D x 72"W x 29.75"H	6' Desk Height Work Station
DT-7AJ-Z	30"D x 84"W x 29.75"H	7' Desk Height Work Station
DT-8AJ-Z	30"D x 96"W x 29.75"H	8' Desk Height Work Station
DTL-5AJ-Z	30"D x 60"W x 35.75"H	5' Lab Height Work Station
DTL-6AJ-Z	30"D x 72"W x 35.75"H	6' Lab Height Work Station
DTL-7AJ-Z	30"D x 84"W x 35.75"H	7' Lab Height Work Station
DTL-8AJ-Z	30"D x 96"W x 35.75"H	8' Lab Height Work Station



- Top: Solid 1 3/4" Hardwood/Maple
- Left: Leg Pedestal
- Right: Two Drawer Base
- Lower Modesty Panel
- Two 16"h Powered Risers
- Shelf: 12"D x 1 3/4" Hardwood/Maple
- Wire Tray
- (1) 3.25" Grommet

Part #	Size	Description
DT-5AF-Z	30"D x 60"W x 29.75"H	5' Desk Height Work Station
DT-6AF-Z	30"D x 72"W x 29.75"H	6' Desk Height Work Station
DT-7AF-Z	30"D x 84"W x 29.75"H	7' Desk Height Work Station
DT-8AF-Z	30"D x 96"W x 29.75"H	8' Desk Height Work Station
DTL-5AF-Z	30"D x 60"W x 35.75"H	5' Lab Height Work Station
DTL-6AF-Z	30"D x 72"W x 35.75"H	6' Lab Height Work Station
DTL-7AF-Z	30"D x 84"W x 35.75"H	7' Lab Height Work Station
DTL-8AF-Z	30"D x 96"W x 35.75"H	8' Lab Height Work Station



- Top: Solid 1 3/4" Hardwood/Maple
- Left: Leg Pedestal
- Right: Four Drawer Base
- Lower Modesty Panel
- Two 16"H Powered Risers
- Shelf: 12"D x 1 3/4" Hardwood/Maple
- Wire Tray
- (1) 3.25" Grommet

Part #	Size	Description
DT-5AD-Z	30"D x 60"W x 29.75"H	5' Desk Height Work Station
DT-6AD-Z	30"D x 72"W x 29.75"H	6' Desk Height Work Station
DT-7AD-Z	30"D x 84"W x 29.75"H	7' Desk Height Work Station
DT-8AD-Z	30"D x 96"W x 29.75"H	8' Desk Height Work Station
DTL-5AD-Z	30"D x 60"W x 35.75"H	5' Lab Height Work Station
DTL-6AD-Z	30"D x 72"W x 35.75"H	6' Lab Height Work Station
DTL-7AD-Z	30"D x 84"W x 35.75"H	7' Lab Height Work Station
DTL-8AD-Z	30"D x 96"W x 35.75"H	8' Lab Height Work Station



- Top: Solid 1 3/4" Hardwood/Maple
- Left: Leg Pedestal
- Right: Six Drawer Base
- Lower Modesty Panel
- Two 16"H Powered Risers
- Shelf: 12"D x 1 3/4" Hardwood/Maple
- Wire Tray
- (1) 3.25" Grommet

Part #	Size	Description
DT-5AC-Z	30"D x 60"W x 29.75"H	5' Desk Height Work Station
DT-6AC-Z	30"D x 72"W x 29.75"H	6' Desk Height Work Station
DT-7AC-Z	30"D x 84"W x 29.75"H	7' Desk Height Work Station
DT-8AC-Z	30"D x 96"W x 29.75"H	8' Desk Height Work Station
DTL-5AC-Z	30"D x 60"W x 35.75"H	5' Lab Height Work Station
DTL-6AC-Z	30"D x 72"W x 35.75"H	6' Lab Height Work Station
DTL-7AC-Z	30"D x 84"W x 35.75"H	7' Lab Height Work Station
DTL-8AC-Z	30"D x 96"W x 35.75"H	8' Lab Height Work Station



- Top: Solid 1 3/4" Hardwood/Maple
- Left: Leg Pedestal
- Center: L.H. Single Door Base
- Right: Leg Pedestal
- Lower Modesty Panel
- Three 16"h Powered Risers
- Shelf: 12"d x 1 3/4" Hardwood/Maple
- Wire Tray



- Top: Solid 1 3/4" Hardwood/Maple
- Left: Leg Pedestal
- Center: Two Drawer Base
- Right: Leg Pedestal
- Lower Modesty Panel
- Three 16"h Powered Risers
- Shelf: 12"d x 1 3/4" Hardwood/Maple
- Wire Tray

Part #	Size	Description
DT-8AJA-Z	30"D x 96"W x 29.75"H	8' - Desk Height Work Station
DT-9AJA-Z	30"D x 108"W x 29.75"H	9' - Desk Height Work Station
DT-10AJA-Z	30"D x 120"W x 29.75"H	10' - Desk Height Work Station
DTL-8AJA-Z	30"D x 96"W x 35.75"H	8' - Lab Height Work Station
DTL-9AJA-Z	30"D x 108"W x 35.75"H	9' - Lab Height Work Station
DTL-10AJA-Z	30"D x 120"W x 35.75"H	10' - Lab Height Work Station

Part #	Size	Description
DT-8AFA-Z	30"D x 96"W x 29.75"H	8' - Desk Height Work Station
DT-9AFA-Z	30"D x 108"W x 29.75"H	9' - Desk Height Work Station
DT-10AFA-Z	30"D x 120"W x 29.75"H	10' - Desk Height Work Station
DTL-8AFA-Z	30"D x 96"W x 35.75"H	8' - Lab Height Work Station
DTL-9AFA-Z	30"D x 108"W x 35.75"H	9' - Lab Height Work Station
DTL-10AFA-Z	30"D x 120"W x 35.75"H	10' - Lab Height Work Station



- Top: Solid 1 3/4" Hardwood/Maple
- Left: Leg Pedestal
- Center: Four Drawer Base
- Right: Leg Pedestal
- Lower Modesty Panel
- Three 16"h Powered Risers
- Shelf: 12"d x 1 3/4" Hardwood/Maple
- Wire Tray



- Top: Solid 1 3/4" Hardwood/Maple
- Left: Leg Pedestal
- Center: Six Drawer Base
- Right: Leg Pedestal
- Lower Modesty Panel
- Three 16"h Powered Risers
- Shelf: 12"d x 1 3/4" Hardwood/Maple
- Wire Tray

Part #	Size	Description
DT-8ADA-Z	30"D x 96"W x 29.75"H	8' - Desk Height Work Station
DT-9ADA-Z	30"D x 108"W x 29.75"H	9' - Desk Height Work Station
DT-10ADA-Z	30"D x 120"W x 29.75"H	10' - Desk Height Work Station
DTL-8ADA-Z	30"D x 96"W x 35.75"H	8' - Lab Height Work Station
DTL-9ADA-Z	30"D x 108"W x 35.75"H	9' - Lab Height Work Station
DTL-10ADA-Z	30"D x 120"W x 35.75"H	10' - Lab Height Work Station

Part #	Size	Description
DT-8ACA-Z	30"D x 96"W x 29.75"H	8' - Desk Height Work Station
DT-9ACA-Z	30"D x 108"W x 29.75"H	9' - Desk Height Work Station
DT-10ACA-Z	30"D x 120"W x 29.75"H	10' - Desk Height Work Station
DTL-8ACA-Z	30"D x 96"W x 35.75"H	8' - Lab Height Work Station
DTL-9ACA-Z	30"D x 108"W x 35.75"H	9' - Lab Height Work Station
DTL-10ACA-Z	30"D x 120"W x 35.75"H	10' - Lab Height Work Station



Wire Management Tray

Full length wire management tray - Measuring 4"D x 4"W with access ports front and rear - Works with all Dura-Tech work stations with modesty panels - May require drilled grommet hole in work surface.

Part #	Description
DTWT - 36	36"L Wire Tray
DTWT - 48	48"L Wire Tray
DTWT - 60	60"L Wire Tray
DTWT - 72	72"L Wire Tray
DTWT - 84	84"L Wire Tray
DTWT - 96	96"L Wire Tray



Lower Modesty Panels

Modesty panels mount between base cabinets or pedestals - Panels measure 15"H - Specify bench configuration when ordering - Special lengths available.

Part #	Description
DTM - 36	36"L Modesty Panel
DTM - 48	48"L Modesty Panel
DTM - 60	60"L Modesty Panel
DTM - 72	72"L Modesty Panel
DTM - 84	84"L Modesty Panel
DTM - 96	96"L Modesty Panel



Riser Shelf Supports

Supports are 3.5"W - Sold in pairs - Available with optional AC power panel - Panel includes (5) outlet, 120V, 15 amp - lighted on/off switch - 6' cord & plug - Shelf sold separately on page 135.

	Height	Without AC	With AC
10" Deep	12"	DTR-1012	DTR-1012-AC
	16"	DTR-1016	DTR-1016-AC
	18"	DTR-1018	DTR-1018-AC
	24"	DTR-1024	DTR-1024-AC
16" Deep	12"	DTR-1612	DTR-1612-AC
	16"	DTR-1616	DTR-1616-AC
	18"	DTR-1618	DTR-1618-AC
	24"	DTR-1624	DTR-1624-AC



Trainer Board Drawer Inserts

Trainer Board Inserts - Incorporate trainer board storage into the 150 series Dura-Tech drawers - Manufactured to accommodate most trainer boards - Contact GMI for specific order details.

Part #	Description
DTD-150	Board Storage Inserts for 150 Dwr.



CPU Racks

Fixed mount CPU rack with Velcro strap - Sturdy 12 gauge steel platform - Adapts easily to most GMI work benches.

Part #	Description
DTCPU-200	Stationary Rack w/Velcro Strap
DTCPU-400	Slide Out/Swivel Rack - Top Mount



Under Shelf Task Light

Under shelf fluorescent task lighting - 120V, 15 amp - Single tube up to 48" - Available with optional cord and on/off switch.

Length	Light Only	Light Cord/Switch
36"	DTSL-36	DTSLC-36
48"	DTSL-48	DTSLC-48

Caster Base Kits for Dura-Tech Cabinets

Use caster base frames to create a mobile work bench with the storage arrangement that best fits your requirements. Mix and match base configurations in the widths indicated. Casters are standard 5" diameter. (2) rigid and (2) swivel casters with brakes are supplied with each frame. Caster frames take the place of the standard 4" recessed kick riser and will add a total of 4.5" in height to a base Dura-Tech cabinet. (EX: A standard 28"H base would measure 32.5"H including top when mounted on a caster base. Recommended for 28"H and 34"H cabinets only. See page 135 for available work surface options.



	Width	Part #	Description
24" Deep	32"	DTCB-2432-5	24"D x 32"W - Caster Base for 32" Total Cabinet Width
	36"	DTCB-2436-5	24"D x 36"W - Caster Base for 36" Total Cabinet Width
	48"	DTCB-2448-5	24"D x 48"W - Caster Base for 48" Total Cabinet Width
	64"	DTCB-2464-5	24"D x 64"W - Caster Base for 64" Total Cabinet Width
	72"	DTCB-2472-5	24"D x 72"W - Caster Base for 72" Total Cabinet Width
28" Deep	32"	DTCB-2832-5	28"D x 32"W - Caster Base for 32" Total Cabinet Width
	36"	DTCB-2836-5	28"D x 36"W - Caster Base for 36" Total Cabinet Width
	48"	DTCB-2848-5	28"D x 48"W - Caster Base for 48" Total Cabinet Width
	64"	DTCB-2864-5	28"D x 64"W - Caster Base for 64" Total Cabinet Width
	72"	DTCB-2872-5	28"D x 72"W - Caster Base for 72" Total Cabinet Width

See Pages 136-139 for Additional Accessories

Our CB-Series locker bases, cabinets, and workstations are offered in a variety of sizes and work surface configurations. GMI locker bases are constructed of 18 gauge steel and feature all welded construction to withstand use in the shop environment. Locker bases are equipped with spring hinges, number plates, and padlock hasps.

Choose from our pre-configured work benches or use individual base components to build a work station to fit your needs.



CBL-120-3.M Workbench



CBR-1150.L Lockers

Locker openings feature spring hinges with padlock hasps. The cabinet shell is one piece all welded construction with a solid top and bottom cap.



Locker doors are provided with number plates. Cabinets can be ordered with a two-tone paint scheme at no additional charge.



CBL-5464-8.M Benches

The optional recessed kick riser base will add 4" to the height of the base cabinets.





Four Student/12 Narrow Locker Workbench

Locker size 12"W x 15"H x 21"D - Spring hinges - Number plates - Padlock hasps (Padlocks not included) - Available with either 2 1/4" solid maple or 2" steel top - "V" denotes (4) 7" woodworking vises supplied with station.

Part #	Size	Description
CBL-5464-12.M	54" X 64" x 33.75"H	2-1/4" Maple Top
CBL-5464-12.MV	54" X 64" x 33.75"H	2-1/4" Maple Top w/Vises
CBL-5464-12.S	54" X 64" x 33.50"H	2" Steel Top
CBL-5464-12.SV	54" X 64" x 33.50"H	2" Steel Top w/Vises
FBR-5464	54" x 64" x 1/4"	Fiber Cover For Steel Top



Four Student/12 Wide Locker Workbench

Locker size 18"W x 10"H x 21"D - Spring hinges - Number plates - Padlock hasps (Padlocks not included) - Available with either 2-1/4" solid maple or 2" steel top - "V" denotes (4) 7" woodworking vises supplied with station.

Part #	Size	Description
CBL-5464-12A.M	54" X 64" x 33.75"H	2-1/4" Maple Top
CBL-5464-12A.MV	54" X 64" x 33.75"H	2-1/4" Maple Top w/Vises
CBL-5464-12A.S	54" X 64" x 33.50"H	2" Steel Top
CBL-5464-12A.SV	54" X 64" x 33.50"H	2" Steel Top w/Vises
FBR-5464	54" x 64" x 1/4"	Fiber Cover For Steel Top



Four Student/8 Locker Workbench

Locker size 18"W x 15"H x 21"D - Spring hinges - Number plates - Padlock hasps (Padlocks not included) - Available with either 2-1/4" solid maple or 2" steel top - "V" denotes (4) 7" woodworking vises supplied with station.

Part #	Size	Description
CBL-5464-8.M	54" X 64" x 33.75"H	2-1/4" Maple Top
CBL-5464-8.MV	54" X 64" x 33.75"H	2-1/4" Maple Top w/Vises
CBL-5464-8.S	54" X 64" x 33.50"H	2" Steel Top
CBL-5464-8.SV	54" X 64" x 33.50"H	2" Steel Top w/Vises
FBR-5464	54" x 64" x 1/4"	Fiber Cover For Steel Top



Four Student/8 Drawer Workbench

(4) 36"W x 31"H x 21"D double drawer base cabinets - Cylinder style locks - Drawers mounted on roller bearing glides - Available with either 2-1/4" solid maple or 2" steel top - "V" denotes (4) 7" woodworking vises supplied with station.

Part #	Size	Description
CBL-5464-8D.M	54" X 64" x 33.75"H	2-1/4" Maple Top
CBL-5464-8D.MV	54" X 64" x 33.75"H	2-1/4" Maple Top w/Vises
CBL-5464-8D.S	54" X 64" x 33.50"H	2" Steel Top
CBL-5464-8D.SV	54" X 64" x 33.50"H	2" Steel Top w/Vises
FBR-5464	54" x 64" x 1/4"	Fiber Cover For Steel Top

CB-Series locker base cabinets are available in a variety of configurations for your storage needs. Constructed of 18 gauge steel utilizing all welded construction. Padlock hasps and number plates are standard. Doors are mounted on durable spring hinges.



Two Door Narrow Locker Base

Overall size: 12"W x 21"D x 31"H
 - Locker openings 10"W x 21"D x 15"H - Padlock hasp - Number plates - Spring hinges - Cylinder lock knockouts - (locks not included) - Available with optional 4"H base riser.

Part #	Description
CBR-1100.L	Two Door Narrow Base
CBR-1100.L3	(3) Base Cabinet Config.
CB-12CR	4"H Riser Base



Two Door Wide Locker Base

Overall size: 18"W x 21"D x 31"H
 - Locker openings 16"W x 21"D x 15"H - Padlock hasp - Number plates - Spring hinges - Cylinder lock knockouts - (locks not included) - Available with optional 4"H base riser.

Part #	Description
CBR-1150.L	Two Door Wide Base
CBR-1150.L3	(3) Base Cabinet Config.
CB-18CR	4"H Riser Base



Three Door Wide Base

Overall size: 18"W x 21"D x 31"H
 - Locker openings 16"W x 21"D x 10"H - Padlock hasp - Number plates - Spring hinges - Cylinder lock knockouts - (locks not included) - Available with optional 4"H base riser.

Part #	Description
CBR-1200.L	Three Door Wide Base
CBR-1200.L3	(3) Base Cabinet Config.
CB-18CR	4"H Riser Base

CB - Base Cabinets

Base cabinets are constructed of 18 gauge steel utilizing all welded construction. Recessed door and drawer pulls. Ball bearing drawer glides with detents in the closed position provide smooth drawer operation. Cabinet doors are mounted on durable recessed hinges. Bases can be used in any combination with work surfaces offered on page 135.



Single Door Base

Overall size: 18"W x 21"D x 31"H
 - Cylinder lock knockout - (locks not included) - Available with optional 4"H base riser.

Part #	Description
CB-400.L	LH Single Door Base
CB-400.R	RH Single Door Base
CB-18CR	4"H Riser Base



Single Drawer/Door Base

Overall size: 18"W x 21"D x 31"H
 - Drawer measures 14"W x 18"D x 12.5"H - Cylinder lock knockouts - (locks not included) - Available with optional 4"H base riser.

Part #	Description
CB-800	One Drawer/Door Base
CB-18CR	4"H Riser Base



Two Drawer Base

Overall size: 18"W x 21"D x 31"H
 - Drawers measure 14"W x 18"D x 12.5"H - Cylinder lock knockouts - (locks not included) - Available with optional 4"H base riser.

Part #	Description
CB-500	Two Drawer Base
CB-18CR	4"H Riser Base



Three Drawer Base

Overall size: 18"W x 21"D x 31"H
 - Drawers measure 14"W x 18"D x 9.75"H - Cylinder lock knockouts - (locks optional) - Available with optional 4"H base riser.

Part #	Description
CB-700	Three Drawer Base
CB-18CR	4"H Riser Base



Four Drawer Base

Overall size: 18"W x 21"D x 31"H
 - Drawers measure 14"W x 18"D x 6.75"H - Cylinder lock knockouts - (locks optional) - Available with optional 4"H base riser.

Part #	Description
CB-600	Four Drawer Base
CB-18CR	4"H Riser Base



Six Drawer Base

Overall size: 18"W x 21"D x 31"H
 - Drawers measure 14"W x 18"D x 4.5"H - Cylinder lock knockouts - (locks optional) - Available with optional 4"H base riser.

Part #	Description
CB-900	Six Drawer Base
CB-18CR	4"H Riser Base



Two Swing Door Base

Overall size: 36"W x 21"D x 31"H - (1) adjustable shelf - Cylinder lock knockouts - (locks optional) - Available with optional 4"H base riser.

Part #	Description
CB-320	Two Door Base
CB-36CR	4"H Riser Base



Two Sliding Door Base

Overall size: 36"W x 21"D x 31"H - (1) adjustable shelf - Cylinder lock knockouts - (locks optional) - Available with optional 4"H base riser.

Part #	Description
CB-350	Two Sliding Door Base
CB-36CR	4"H Riser Base



Two Drawer/Two Swing Door Base

Overall size: 36"W x 21"D x 31"H - Drawers measure 15.25"W x 18"D x 6.75"H - (1) adjustable shelf - Cylinder lock knockouts - (locks optional) - Available with optional 4"H base riser.

Part #	Description
CB-360	Two Drawer/Two Door Base
CB-36CR	4"H Riser Base



Wall Workbench

60"L x 24"D x 36 3/4"H - Six opening locker base - Locker size 16"W x 21"D x 10"H - Spring hinges - Number plates - Padlock hasps (Padlocks not included) - Includes 4" riser base on cabinets - Available with either 1-3/4" solid maple or 2" steel top.

Part #	Size	Description
CBL-1500.M	60"W x 24"D x 36.75"H	1-3/4" Maple Top
CBL-1500.S	60"W x 24"D x 37.00"H	2" Steel Top
FBR-2460	60"W x 24"D x 1/4"H	Fiber Cover For Steel Top

*Overall height with maple top.



Wall Workbench

120"W x 24"D x 36.75"H - (2) 36"W x 21"D double door bases - (1) adjustable shelf per cabinet - (1) 36"W x 21"D four drawer base cabinet - Cylinder style locks - Includes 4" riser base on cabinets - Available with either 1-3/4" solid maple or 2" steel top.

Part #	Size	Description
CBL-120-21.M	120"W x 24"D x 36.75"H	1-3/4" Maple Top
CBL-120-21.S	120"W x 24"D x 37.00"H	2" Steel Top
FBR-24120	120"W x 24"D x 0.25"	Fiber Cover For Steel Top



Wall Workbench

120"W x 24"D x 36.75"H - (2) 36"W x 21"D double door bases - (1) adjustable shelf per cabinet - (1) 36"W x 21"D six drawer base cabinet - Cylinder style locks - Includes 4" riser base on cabinets - Available with either 1-3/4" solid maple or 2" steel top.

Part #	Size	Description
CBL-120-22.M	120"W x 24"D x 36.75"H	1-3/4" Maple Top
CBL-120-22.S	120"W x 24"D x 37.00"H	2" Steel Top
FBR-24120	120"W x 24"D x 0.25"	Fiber Cover For Steel Top



Wall Workbench

120"W x 24"D x 36.75"H - 18 opening locker base - Locker size 12"W x 15"H x 21"D - Spring hinges - Number plates - Padlock hasps (Padlocks not included) - Includes 4" riser base on cabinets - Available with either 1-3/4" solid maple or 2" steel top.

Part #	Size	Description
CBL-120-18.M	120"W x 24"D x 36.75"H	1-3/4" Maple Top
CBL-120-18.S	120"W x 24"D x 37.00"H	2" Steel Top
FBR-24120	120"W x 24"D x 0.25"	Fiber Cover For Steel Top



Wall Workbench

120"W x 24"D x 36.75"H - (3) 36"W x 21"D double door bases - Includes 4" riser base on cabinets - Cylinder style locks - (1) adjustable shelf per cabinet - Available with either 1-3/4" solid maple or 2" steel top.

Part #	Size	Description
CBL-120-3.M	120"W x 24"D x 36.75"H	1-3/4" Maple Top
CBL-120-3.S	120"W x 24"D x 37.00"H	2" Steel Top
FBR-24120	120"W x 24"D x 0.25"	Fiber Cover For Steel Top



Wall Workbench

120"W x 24"D x 36.75"H - 12 opening locker base - Locker size 16"W x 21"D x 15"H - Spring hinges - Number plates - Padlock hasps (Padlocks not included) - Includes 4" riser base on cabinets - Available with either 1-3/4" solid maple or 2" steel top.

Part #	Size	Description
CBL-120-12.M	120"W x 24"D x 36.75"H	1-3/4" Maple Top
CBL-120-12.S	120"W x 24"D x 37.00"H	2" Steel Top
FBR-24120	120"W x 24"D x 0.25"	Fiber Cover For Steel Top



Wall Workbench

120"W x 24"D x 36.75"H - 18 opening locker base - Locker size 16"W x 21"D x 10"H - Spring hinges - Number plates - Padlock hasps (Padlocks not included) - Includes 4" riser base on cabinets - Available with either 1-3/4" solid maple or 2" steel top.

Part #	Size	Description
CBL-120-18-3.M	120"W x 24"D x 36.75"H	1-3/4" Maple Top
CBL-120-18-3.S	120"W x 24"D x 37.00"H	2" Steel Top
FBR-24120	120"W x 24"D x 0.25"	Fiber Cover For Steel Top

*Overall height with maple top.



Four Student Double Door Workbench

(2) 36"W x 31"H x 21"D double door base cabinets - Cylinder style locks - (1) adjustable shelf per cabinet - Available with either 2 1/4" solid maple or 2" steel top - "V" denotes (4) 7" woodworking vises supplied with station.

Part #	Size	Description
CBL-5464-4.M	54" X 64" x 33.75"H	2-1/4" Maple Top
CBL-5464-4.MV	54" X 64" x 33.75"H	2-1/4" Maple Top w/Vises
CBL-5464-4.S	54" X 64" x 33.50"H	2" Steel Top
CBL-5464-4.SV	54" X 64" x 33.50"H	2" Steel Top w/Vises
FBR-5464	54" x 64" x 0.25"	Fiber Cover For Steel Top



Four Student Open Base Workbench

Lower steel shelf with leg stringers - Floor anchor pads - Available with either 2 1/4" solid maple or 2" steel top - "V" denotes (4) 7" woodworking vises supplied with station.

Part #	Size	Description
CBL-5464-0.M	54" X 64" x 33.75"H	2-1/4" Maple Top
CBL-5464-0.MV	54" X 64" x 33.75"H	2-1/4" Maple Top w/Vises
CBL-5464-0.S	54" X 64" x 33.50"H	2" Steel Top
CBL-5464-0.SV	54" X 64" x 33.50"H	2" Steel Top w/Vises
B-CST5	5" Diameter	Caster Kit
FBR-5464	54" x 64" x 0.25"	Fiber Cover For Steel Top

CB-Series Bench Accessories



Swivel Stool

Mounting bracket attaches to a cabinet side - Stool contacts floor when weight is applied - 13" diameter steel seat is pneumatically height adjustable - All welded construction.

Part #	Description
PGS-1300	Cabinet Mounted Stool



Wood Workers Vise

Solid steel dog in front jaw - Machined toe in jaws provide solid grip - Fits up to 3" deep tops - Continuous action.

Part #	Jaw Size	Description
WV-470-CA	3-1/2" x 7"	Continuous Action Vise
WV-570-CA	3-1/2" x 10"	Continuous Action Vise



Machinist Vise

Reversible jaws - 360 degree swivel base - Knurled jaw faces - 5-1/2" wide jaws - 6" jaw opening - 3-3/4" throat depth.

Part #	Jaw Size	Description
MV-270-CA	5-1/2" x 6"	Machinist Vise



Cylinder Locks

Chrome cylinder locks fit door and drawer configurations and are available keyed alike or KDMK.

Part #	Description
D-LCK-415	Door Lock Keyed Alike
D-LCK-KDMK	Door Lock KDMK
DWR-LCK-415	Drawer Lock Keyed Alike
DWR-LCK-KDMK	Drawer Lock Keyed Alike



CB-Series Riser Base

Optional base is 4"H - Fastens to underside of cabinet - Includes (4) floor levelers - Recessed 3" from front - Available for 18"W and 36"W cabinets.

Part #	Description
CB-18CR	18"W Cabinet Riser Base
CB-36CR	36"W Cabinet Riser Base



CB-5464-4 shown with stool and vise accessories.

GMI mobile work benches are constructed to meet the tough demands of a high use environment. All welded construction and heavy gauge steel will withstand years of use. Full extension ball bearing drawer glides. Benches are standard with four 5" heavy duty casters and are offered with several different top styles. Available in a variety of configurations to fit most applications.

GMI also offers several mobile work stations for specialty use.



MG-88-108.VAC Mobile Work Station

Mobile benches with vac system feature built in dust collection ports in the work surface.



MG-400.M Mobile Work Bench

Vac system enclosure cabinet allows proper air flow and helps reduce noise.



Full extension drawer glides.





Double Door Mobile Bench

Overall size - 38"W x 24"D x 34"H - Two locking doors - 5" locking casters - (2) Adjustable shelves - Recessed aluminum handles - Keyed cylinder lock - All welded steel construction.

Part #	Description
MG-200.M	Bench w/Hardwood Top
MG-200.STL	Bench w/Steel Top
MG-200.L	Bench w/Laminate Top
MGR-200	Bench w/Robotics Top - See Page 59
MG-200.SHV	Additional Lower Shelf
MG-200.BES	4"H Back and End Rails



Five Drawer Mobile Bench

Overall size - 38"W x 24"D x 34"H - Five Drawers 32"W x 21"D x 5.25"H - 125 lb full extension drawer glides - Individual cylinder locks keyed alike - All welded steel construction.

Part #	Description
MG-250.M	Bench w/Hardwood Top
MG-250.STL	Bench w/Steel Top
MG-250.L	Bench w/Laminate Top
MGR-250	Bench w/Robotics Top - See Page 59
MG-250.BES	4"H Back and End Rails



Double Door Mobile Bench w/ Open Tool Storage Panel

Overall size - 60"W x 30"D x 34"H - 36"W base with two locking doors - (1) adjustable shelves - Recessed aluminum handles - Keyed cylinder lock - 20" wide open tool storage panel - 5" locking casters - All welded steel construction.

Part #	Description
MG-300.M	Bench w/Hardwood Top
MG-300.STL	Bench w/Steel Top
MG-300.L	Bench w/Laminate Top
MGR-300	Bench w/Robotics Top - See Page 59
MG-300.SHV	Additional Lower Shelf
MG-300.BES	4"H Back and End Rails



Mobile Bench with Computer Storage

Overall size - 48"W x 30"D x 34"H - Ideal for small CNC equipment - Keyboard drawer - Vented CPU cabinet - Large storage area can be used for printer - Individual cylinder locks keyed alike - 5" locking casters - All welded steel construction.

Part #	Description
MG-3048.M	Bench w/Hardwood Top
MG-3048.STL	Bench w/Steel Top
MG-3048.L	Bench w/Laminate Top
MGR-3048	Bench w/Robotics Top - See Page 59
MG-3048.SHV	Additional Lower Shelf
MG-3048.BES	4"H Back and End Rails



Two Drawer/Double Door Mobile Bench

Overall size - 60"W x 30"D x 34"H - (2) 22"W storage drawers - 125 lb full extension drawer glides - Large lower storage compartment with (2) locking doors - Recessed aluminum handles - Individual cylinder locks keyed alike - 5" locking casters - All welded steel construction.



Three Drawer/Double Door Mobile Bench

Overall size - 75"W x 30"D x 34"H - (3) 22"W storage drawers - 125 lb full extension drawer glides - Large lower storage compartment with (2) locking doors - Recessed aluminum handles - Individual cylinder locks keyed alike - 5" locking casters - All welded steel construction.

Part #	Description
MG-66.M	Bench w/Hardwood Top
MG-66.STL	Bench w/Steel Top
MG-66.L	Bench w/Laminate Top
MGR-66	Bench w/Robotics Top - See Page 59
MG-66.SHV	Additional Lower Shelf
MG-66.BES	4"H Back and End Rails

Part #	Description
MG-88.M	Bench w/Hardwood Top
MG-88.STL	Bench w/Steel Top
MG-88.L	Bench w/Laminate Top
MGR-88	Bench w/Robotics Top - See Page 59
MG-88.SHV	Additional Lower Shelf
MG-88.BES	4"H Back and End Rails



Four Drawer/Double Door Mobile Bench

Overall size - 72"W x 30"D x 34"H - 32"W Four drawer base cabinet - 125 lb full extension drawer glides - 32"W (2) door base cabinet - (1) Adjustable shelf - Recessed aluminum handles - Individual cylinder locks keyed alike - 5" locking casters - All welded steel construction.



Six Drawer/Double Door Mobile Bench

Overall size - 72"W x 30"D x 34"H - 32"W Six drawer base cabinet - 125 lb full extension drawer glides - 32"W (2) door base cabinet - (1) Adjustable shelf - Recessed aluminum handles - Individual cylinder locks keyed alike - 5" locking casters - All welded steel construction.

Part #	Description
MG-400.M	Bench w/Hardwood Top
MG-400.STL	Bench w/Steel Top
MG-400.L	Bench w/Laminate Top
MGR-400	Bench w/Robotics Top - See Page 59
MG-400.SHV	Additional Lower Shelf
MG-400.BES	4"H Back and End Rails

Part #	Description
MG-600.M	Bench w/Hardwood Top
MG-600.STL	Bench w/Steel Top
MG-600.L	Bench w/Laminate Top
MGR-600	Bench w/Robotics Top - See Page 59
MG-600.SHV	Additional Lower Shelf
MG-600.BES	4"H Back and End Rails



Single Drawer/Double Door Mobile Bench

Overall size - 38"W x 24"D x 34"H - (1) 34"W Storage drawer - Large lower storage compartment with (2) locking doors - (1) Adjustable shelf - Recessed aluminum handles - Individual cylinder locks keyed alike - 5" locking casters - All welded steel construction.

Part #	Description
MG-225.M	Bench w/Hardwood Top
MG-225.STL	Bench w/Steel Top
MG-225.L	Bench w/Laminate Top
MGR-225	Bench w/Robotics Top - See Page 59
MG-225.SHV	Additional Lower Shelf
MG-225.BES	4"h Back and End Rails



Single Drawer/Single Door Mobile Bench

Overall size - 30"W x 24"D x 38"H - One drawer measures 21.75"W x 20.125"D x 2.50"H - 125 lb full extension drawer glides - Single door lower storage area measures 21.50"W x 23"D x 18.00"H - (1) Adjustable shelf - Recessed aluminum handles - Individual cylinder locks keyed alike - 4" locking casters - All welded steel construction.

Part #	Description
MG-100.STL	Steel Top Bench w/ 4" Back and End Rails
MG-100.SHV	Additional Lower Shelf



Two Drawer/Single Door Mobile Bench

Overall size - 30"W x 24"D x 38"H - Two drawers measure 21.75"W x 20.125"D x 2.50"H - 125 lb full extension drawer glides - Single door lower storage area measures 21.50"W x 23"D x 14.45"H - (1) Adjustable shelf - Recessed aluminum handles - Individual cylinder locks keyed alike - 4" locking casters - All welded steel construction.

Part #	Description
MG-125.STL	Bench w/Steel Top
MG-125.SHV	Additional Lower Shelf
MG-125.BES	4"h Back and End Rails



Forensic - Finger Print Mobile Bench

Overall size - 60"W x 30"D x 34"H - (1) 30" w double door base cabinet with (1) Adjustable shelf - Perforated steel top with enclosed bottom attaches to built in vacuum system - Vac enclosure cabinet with 10hp industrial vac system - 1-1/4" laminate top included for dual use as standard work bench - Recessed aluminum handles - Individual cylinder locks keyed alike - 5" locking casters - All welded steel construction.

Part #	Description
MG-1000.VAC	Bench w/Steel Top and Laminate Top
MG-1000.SHV	Additional Lower Shelf



Shown with Optional Tools



Enclosed Vac Cabinet



Back View

The perfect work bench for small bench top power tools. Built in dust collection system features a 5 HP vacuum with (3) attachment hoses for equipment hook up. The three full extension upper drawers are ideal for tool and supply storage. The large open storage area below can be used to store tools when not in use. The 72-VAC model has an open shelf for the vacuum while the 96" and 108" models have an enclosed vacuum cabinet. The all welded 14 and 16 gauge steel cabinet will withstand years of use.

MG-88 Series Features:

- (3) upper drawers measure 22"W x 24"D x 5.5"H.
- 125 lb full extension glides.
- 1-3/4" tops w/ flush mounted vacuum ports.
- All welded 14 and 16 gauge steel.
- Recessed aluminum handles.
- Cylinder locks.
- 5" Heavy duty locking casters.

Not for use with metal or aluminum operations.

Part #	Description
MG-88-72-VAC	34"D x 93"W - Exposed Vac Shelf
MG-88-96-VAC	34"D x 96"W - Enclosed Vac Cabinet
MG-88-108-VAC	34"D x 108"W - Enclosed Vac Cabinet

Part #	Description
MG-100.PR	Optional Power Cord Reel with 25' Cord
MG-36.ET	Optional Industrial Power Outlet Strip
MG-88.SHV	Optional Interior Lower Shelf



Back View

This mobile work station features (2) 32"W x 24"D double door bases with (1) adjustable shelf each. Door cabinets have a three point lock mechanism for added security. The dust collection system features a 5 HP vacuum with (3) collection ports mounted into the rear of the work surface. Bench is supplied with (3) attachment hoses for equipment hook up. All MG-320 models have an open shelf and security strap for the vacuum.

MG-320 Series Features:

- 1-3/4" tops with flush mounted vacuum ports.
- 32" wide storage cabinets.
- All welded 16 gauge steel.
- Recessed aluminum handles.
- Cylinder locks.
- 5" Heavy duty locking casters.

Not for use with metal or aluminum operations.

Part #	Description
MG-320-72-VAC	34"D x 93"W - Exposed Vac Shelf
MG-320-96-VAC	34"D x 96"W - Exposed Vac Shelf
MG-320-108-VAC	34"D x 108"W - Exposed Vac Shelf

Part #	Description
MG-100.PR	Optional Power Cord Reel with 25' Cord
MG- 36.ET	Optional Industrial Power Outlet Strip
MG-320.SHV	Optional Interior Lower Shelf

MGR Robotics

These work stations are perfect for robotics and manufacturing training cell applications. Robotics work stations feature a galvanized steel perforated top to allow the mounting of components in any configuration. Three large slots at the rear of the work surface allow cables to be neatly run underneath. Accessories can be added to accommodate monitor arms, keyboard trays, and power outlets.

Robotics work surfaces can be used with a number of GMI work bench bases and cabinets as well as most of the MG-series mobile work benches.



Open Robotic Work Bench

Base constructed from heavy 1-1/2" square tube - Work surface height 34"H - 11 gauge perforated galvanized steel top with (3) large cable slots - 5" locking casters - Fixed 16 gauge steel lower shelf provides 14" clear height - All welded steel construction.

Part #	Description
MGR-3060.G	30"D x 60"W x 40"H - Open Work bench
MGR-3072.G	30"D x 72"W x 40"H - Open Work bench



Robotic Work Cell Top Assembly

Upper worksurface is 11 gauge perforated galvanized steel with (3) large cable slots - Perforations are 5/16" x 1-1/2" spaced on 2" centers - Lower section is 14 gauge steel with a 1-1/2" lip up on all four sides - Top assembly will bolt to most GMI work bench bases.

Part #	Description
MGR-60.G	30"D x 60"W x 7"H - Robotics Work Cell Top Assembly
MGR-75.G	30"D x 75"W x 7"H - Robotics Work Cell Top Assembly

Simulator Controller Cart

Mobile cart for secure moving of Haas and FANUC simulation controllers. Heavy gauge welded components ensure the cart will stand up to years of use. Controller holder brackets are adjustable to accept Haas and FANUC controllers, brackets feature rubber pads to securely grip but also prevent shock during transport to different areas. Adjustable height controller mount and laminate work platform. 4" locking casters. Integrated power strip.

Part #	Description
MST-400-P-SP	Machine Control Stand - Fits Fanuc & Haas Units

Controller Cart Features:

- 24"D x 24"W x 71"H
- Designed to hold Fanuc and Haas controllers
- 4" Swivel Casters
- (1) Adjustable Keyboard/Writing Surface
- (1) Power Outlet with 10' Cord



Shown with Haas Controller



Two Door Mobile Bench

Overall size - 24"D x 39.50"H - All welded 12 gauge steel cabinet construction - Two locking doors - Doors are mounted on 3/8" steel pins with brass bushings - Welded hinges - Solid steel handle accepts heavy padlock (not included) - Three point latching system - (2) Adjustable shelves are 14 gauge steel with formed edges - 6" locking casters - 7 gauge steel top with 2" lip up on (3) sides.

Part #	Description
EXM-200-36	36"W - Two Door EX Mobile Bench
EXM-200-48	48"W - Two Door EX Mobile Bench



Clear View Two Door Mobile Bench

Overall size - 24"D x 39.50"H - All welded 12 gauge steel cabinet construction - Two locking doors - Doors are mounted on 3/8" steel pins with brass bushings - Welded hinges - 3/16" polycarbonate clear panels mounted in doors - Solid steel handle accepts heavy padlock (not included) - Three point latching system - (2) Adjustable shelves are 14 gauge steel with formed edges - 6" locking casters - 7 gauge steel top with 2" lip up on (3) sides.

Part #	Description
EXM-200.CV-36	36"W - Two Door Clear View EX Mobile Bench
EXM-200.CV-48	48"W - Two Door Clear View EX Mobile Bench



Three Drawer Mobile Bench

Overall size - 24"D x 39.50"H - All welded 12 gauge steel cabinet construction - (2) half width 6"H drawers & (1) full width 6"H drawer - Drawers mounted on 250 lb ball bearing glides - Doors are mounted on 3/8" steel pins with brass bushings - Welded hinges - Solid steel handle accepts heavy padlock (not included) - Three point latching system - 6" locking casters - 7 gauge steel top with 2" lip up on (3) sides.

Part #	Description
EXM-350-36	36"W - Three Drawer EX Mobile Bench
EXM-350-48	48"W - Three Drawer EX Mobile Bench



Four Drawer Mobile Bench

Overall size - 24"D x 39.50"H - All welded 12 gauge steel cabinet construction - (4) half width 6"H drawers - Drawers mounted on 250 lb ball bearing glides - Doors are mounted on 3/8" steel pins with brass bushings - Welded hinges - Solid steel handle accepts heavy padlock (not included) - Three point latching system - 6" locking casters - 7 gauge steel top with 2" lip up on (3) sides.

Part #	Description
EXM-450-36	36"W - Four Drawer EX Mobile Bench
EXM-450-48	48"W - Four Drawer EX Mobile Bench



Five Drawer Mobile Bench

Overall size - 24"D x 39.50"H - All welded 12 gauge steel cabinet construction - (4) half width 6"H drawers & (1) full width 6"H drawer - Drawers mounted on 250 lb ball bearing glides - Doors are mounted on 3/8" steel pins with brass bushings - Welded hinges - Solid steel handle accepts heavy padlock (not included) - Three point latching system - 6" locking casters - 7 gauge steel top with 2" lip up on (3) sides.

Part #	Description
EXM-550-36	36"W - Five Drawer EX Mobile Bench
EXM-550-48	48"W - Five Drawer EX Mobile Bench



Drawer/Shelf Maintenance Bench

Overall size - 24"D x 39.50"H - All welded 12 gauge steel cabinet construction - (6) half width 4"H drawers - Drawers mounted on 250 lb ball bearing glides - Doors are mounted on 3/8" steel pins with brass bushings - Welded hinges - Solid steel handle accepts heavy padlock (not included) - Three point latching system - (1) adjustable shelf is 14 gauge steel with formed edges - 6" locking casters - 7 gauge steel top with 2" lip up on (3) sides.

Part #	Description
EXM-600-36	36"W - Six Drawer/Shelf EX Mobile Bench
EXM-600-48	48"W - Six Drawer/Shelf EX Mobile Bench



Maintenance Bench - 6 Drawer/Bin Storage

Overall size - 24"D x 39.50"H - All welded 12 gauge steel cabinet construction - (6) half width 4"H drawers - 250 lb ball bearing glides - Doors are mounted on 3/8" steel pins with brass bushings - Welded hinges - Solid steel handle accepts heavy padlock (not included) - Three point latching system - Door mounted small plastic bins measure 4.125"W x 7.375"D x 3"H - Bins securely attach to mounting rail - Bins are easily removable - (2) adjustable shelves are 14 gauge steel with formed edges - 6" locking casters - 7 gauge steel top with 2" lip up on (3) sides.

Part #	Description
EXM-650BN-36	36"W - Six Drawer/Bin EX Mobile Bench
EXM-650BN-48	48"W - Six Drawer/Bin EX Mobile Bench



Maintenance Bench - 12 Drawer

Overall size 24"D x 39.50"H - All welded 12 gauge steel cabinet construction - (12) half width 4"H drawers - 250 lb ball bearing glides - Doors are mounted on 3/8" steel pins with brass bushings - Welded hinges - Solid steel handle accepts heavy padlock (not included) - Three point latching system - 6" locking casters - 7 gauge steel top with 2" lip up on (3) sides.

Part #	Description
EXM-700-36	36"W - 12 Drawer EX Mobile Bench
EXM-700-48	48"W - 12 Drawer EX Mobile Bench



Bin/Shelf Mobile Bench

Overall size - 60"W x 24"D x 39.50"H - All welded 12 gauge steel cabinet construction - (9) Removable large plastic bins measure 8.25"W x 14.75"D x 7"H - (1) Adjustable height shelf - Doors mounted on 3/8" steel pins with brass bushings - Welded hinges - Solid steel handle accepts heavy padlock (not included) - Three point latching system - 6" locking casters - 7 gauge steel top with 2" lip up on (3) sides.

Part #	Description
EXM-750-60	60"W - (9) Bin / Shelf EX Mobile Bench



Four Drawer/Shelf Mobile Bench

Overall size - 24"D x 39.50"H - All welded 12 gauge steel cabinet construction - (4) 2/3 width 4"H drawers - Drawers mounted on 250 lb ball bearing glides - (1) 1/3 width adjustable height shelf - (1) Full width shelf - Doors are mounted on 3/8" steel pins with brass bushings - Welded hinges - Solid steel handle accepts heavy padlock (not included) - Three point latching system - 6" locking casters - 7 gauge steel top with 2" lip up on (3) sides.

Part #	Description
EXM-800-36	36"W - Four Drawer / Shelf EX Mobile Bench
EXM-800-48	48"W - Four Drawer / Shelf EX Mobile Bench



12 Drawer/Three Door Maintenance Bench -

Overall size - 60"W x 24"D x 39.50"H - All welded 12 ga steel construction - (12) half width 4"H drawers - 250 lb ball bearing glides - 12"D locking side compartment w/ (2) adj. height shelves - Doors mounted on 3/8" steel pins with brass bushings - Solid steel handle accepts heavy padlock (not included) - Three point latching system - 6" locking casters - 7 gauge steel top with 2" lip up on (3) sides.

Part #	Description
EXM-700SC-60	60"W - (12) Drawer / Side Compartment Bench



Multi-Shift Three Door Cabinet

Overall size - 60"W x 24"D x 39.50"H - All welded 12 gauge steel cabinet construction - Three individually locking compartments w/ 2 adjustable height shelves in each section - Doors are mounted on 3/8" steel pins with brass bushings - Welded hinges - Solid steel handles accept heavy padlock (not included) - Three point latching system - 6" locking casters - 7 gauge steel top with 2" lip up on (3) sides.

Part #	Description
EXM-300MS-60	60"W - (3) Individual Locking Compartment Bench

Tear Down Cart

Portable carts for work where oil and fluids can be a problem - All welded construction of heavy gauge steel - Perforated galvanized steel work surface with lower drain pan. Lower shelf has a 1-1/2" lip with a 2 gallon oil/fluid container. Optional 2" high back and end stops around work surface. (2) rigid and (2) swivel locking 5" heavy duty casters. 1500 lb capacity.



Part #	Size
SC-2436-TD	24"D x 36"W Perforated Top
SC-2442-TD	24"D x 42"W Perforated Top
SC-2448-TD	24"D x 48"W Perforated Top
SC-2460-TD	24"D x 60"W Perforated Top

Add .SS to cart for optional back and end stops.

Tool Holder Cart

Store and transport CNC tools safely with our GMCR series tool holder carts - Available in both single and double sided configurations - Shelf positions are adjustable on 2" centers - Shelf supports can be positioned at 90 degrees or slanted down at a 15 degree angle - Heavy duty 5" casters mounted to reinforced rails under base - Two rubber comfort pull handles - Tool holders can be mixed and matched to accommodate a variety of tool sizes.



Features:

- Shelf holders to accommodate most style tools.
- Available in both single and dual sided carts.
- Two position shelf mounting option.
- Sturdy all welded steel construction.
- Heavy duty 5" caster base.
- Comfort grip handles.
- Large lower tray.

Specify Tool Type and Quantity Each When Ordering.



Shelves can be positioned either flat or at a 15 degree down angle.

Available Tool Holders:

- 35 Taper
- 40 Taper
- 45 Taper
- 50 Taper
- HSK-63A
- HSK-100A
- C4
- C5
- C6

How To Order:

- 1: Determine style of cart. Single or double.
 - 2: Choose type(s) of holders for shelf.
 - 3: Order (3) shelf assemblies per side.
- EX: (1) GMCR-2460-S (*Single Sided Rack*)
(3) GMCR-SHL-HSK100A (*Shelves*)



Dual Sided Cart

Part #	Description
GMCR-2460-S	60"W x 24"D x 54"H Single Sided Tooling Cart Frame
GMCR-2460-D	60"W x 42"D x 54"H Double Sided Tooling Cart Frame
GMCR - SHL__	Shelf Assembly - Add Holder Designation When Ordering

General Service/Utility Carts



Service Cart

General Purpose Utility Cart - 11 gauge steel uprights - 11 gauge steel shelves - Welded construction - Carts have 1-1/2"H retainer edges on shelves - (2) rigid and (2) swivel locking 5" heavy duty casters - 1500 lb capacity. Available in a 2, 3, 4, and 5 shelf configuration.

	Width	(2) Shelf Cart - 36"H	(3) Shelf Cart - 60"H	(4) Shelf Cart - 60"H	(5) Shelf Cart - 69"H
24" Deep	36"	SC-2436-2	SC-2436-3	SC-2436-4	SC-2436-5
	42"	SC-2442-2	SC-2442-3	SC-2442-4	SC-2442-5
	48"	SC-2448-2	SC-2448-3	SC-2448-4	SC-2448-5
	60"	SC-2460-2	SC-2460-3	SC-2460-4	SC-2460-5



Low Profile Cart

Low Profile Utility Cart - 11 gauge steel uprights - 11 gauge steel shelves - Welded construction - Carts have 1-1/2"H retainer edges on shelves - (2) rigid and (2) swivel locking 5" heavy duty casters - 28" top shelf height - Handle is 10" above top shelf - 1500 lb capacity.

	Width	Part Number	Description
24" Deep	36"	SC-2436-L	Low Profile Cart
	42"	SC-2442-L	Low Profile Cart
	48"	SC-2448-L	Low Profile Cart
	60"	SC-2460-L	Low Profile Cart

GMTP-Tool Panels/Carts



GMTP-1836 Panels shown with "A" frame assembly on SC-Cart

Tooling carts provide a great way to store tools near your work or assembly area. Panel "A" frames attach to most GMI SC-Series carts. Tool panels are available in a variety of sizes and in both finished metal or stainless steel. Panels have .375" square holes on 1.5" centers and accommodate most tool holders designed for square holes on 1.5" centers. Standard color is structural gray. Special sizes and colors available.



Tool Board Detail

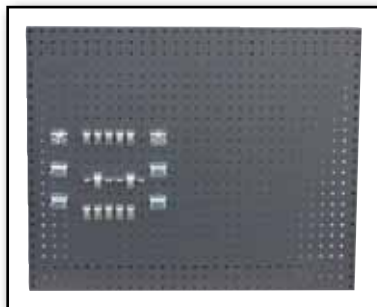

Part #	Description
GMTP-1818	18"W x 18"H Tool Panel
GMTP-1830	30"W x 18"H Tool Panel
GMTP-1836	36"W x 18"H Tool Panel
GMTP-1848	48"W x 18"H Tool Panel
GMTP-3636	36"W x 36"L Wall Mounted Tool Panel
GMTP-4848	48"W x 48"L Wall Mounted Tool Panel
GMTP-4860	48"W x 60"L Wall Mounted Tool Panel
GM-18-AF	"A" Frame For 18"H Panels
Add .SS	For Stainless Steel Panels

Wall Mounted Tool Panels

Tool panels are available in a variety of sizes and in both finished metal or stainless steel. Panels have .375" square holes on 1.5" centers and accommodate most tool holders designed for square holes on 1.5" centers. Standard color is structural gray. Special sizes and colors available.

SEC-600 Series Sport Equipment Cart

Sports gear storage carts are constructed from 16 gauge furniture grade steel - Steel exterior components feature all welded construction - Open design for easy access - (1) full width uniform hanger bar - (3) fixed shelves - Durable 5" heavy duty casters with Polyurethane wheel over aluminum hub - (8) rubber corner protectors on outside edges - (2) push handles on exterior.



Part #	Description
SEC-600-48	48"W x 24"D x 66"H - Open Sports Equipment Cart
SEC-600-60	60"W x 24"D x 66"H - Open Sports Equipment Cart
SEC-600-72	72"W x 24"D x 66"H - Open Sports Equipment Cart

SEC-784 Series Mobile Sport Equipment Cabinet

Sports gear storage cabinets are constructed from 16 gauge furniture grade steel - Steel exterior components feature all welded construction - Vented double doors mounted on (3) welded hinge assemblies - Rubber door pulls - Interior features (1) full width uniform hanger bar - Pad lock door latch - (1) full width shelf - (8) rubber corner protectors on outside edges - (2) push handles on exterior - 5" heavy duty casters - (2) rigid and (2) swivel with brake - Polyurethane wheel over aluminum hub - Available in two standard sizes.



Part #	Description
SEC-784-48	48"W x 24"D x 66"H - Vented Sports Equipment Cabinet
SEC-784-60	60"W x 24"D x 66"H - Vented Sports Equipment Cabinet

SESL-500 Sports Gear Storage Locker

Securely store expensive sports equipment in our sports gear storage locker - Storage locker is constructed from 16 and 18 gauge furniture grade steel - (5) fixed shelves - Steel exterior components feature all welded construction - Secure locking door with handle - Sturdy welded door hinges - Handle accepts standard padlock - Solid back panel - Wire mesh front and sides - Durable polyurethane finish - Available in several sizes.

Part #	Description
SESL-500-18	18"W x 24"D x 72"H Sports Locker
SESL-500-24	24"W x 24"D x 72"H Sports Locker
SESL-500-30	30"W x 24"D x 72"H Sports Locker



Secure locking handle accepts standard padlock.



Our B Series work benches are suitable for use in a variety of applications including assembly, maintenance, production, and instructional training. All work benches are built to withstand heavy use and provide years of service. Standard duty leg assemblies are constructed of 12 and 14 gauge formed steel channel. All legs feature all welded construction. Heavy duty 11 gauge steel leg assemblies are available. Floor anchor pads will accept optional leveler feet.



Our BA-Series leg features a formed galvanized steel base leg insert with height adjustments on 1" centers.



Optional lower shelf features a hemmed rear back stop and a double folded front edge for added strength.



Our BT-Series leg features a tubular steel base with height adjustments on 1" centers. A 1-1/2" diameter floor leveler is standard.





Fixed height work benches are suitable for use in a variety of applications including assembly, maintenance, production, and instructional training. The base legs are constructed of 12 and 14 gauge formed steel channel. Floor anchor pads will accept optional leveler feet. All welded leg assemblies. Leg height is 34" - Add top selection thickness for overall height.



Adjustable height work benches are ideal for use in applications requiring a variety of work station heights. Leg bases will adjust a full 8-1/2". Base legs are constructed of 12 and 14 gauge formed steel channel (optional 11 gauge steel available). Floor anchor pads will accept optional leveler feet. All welded leg assemblies. Leg height is adjustable from 27" to 36" - Add top selection thickness for overall height.



Tubular base work benches provide a clean appearance. The stations are constructed from 2" square tube steel. All welded leg assemblies include floor leveler feet. Adjustable height from 27" to 36" - Add top selection thickness for overall height.



Work Bench with Stringer

48"W	60"W	72"W	84"W	96"W
B-304S	B-305S	B-306S	B-307S	B-308S
B-364S	B-365S	B-366S	B-367S	B-368S
B-304SS	B-305SS	B-306SS	B-307SS	B-308SS
B-364SS	B-365SS	B-366SS	B-367SS	B-368SS
B-304M	B-305M	B-306M	B-307M	B-308M
B-364M	B-365M	B-366M	B-367M	B-368M
B-304L	B-305L	B-306L	B-307L	B-308L
B-364L	B-365L	B-366L	B-367L	B-368L
B-304LE	B-305LE	B-306LE	B-307LE	B-308LE
B-364LE	B-365LE	B-366LE	B-367LE	B-368LE
B-304R	B-305R	B-306R	B-307R	B-308R
B-364R	B-365R	B-366R	B-367R	B-368R

- 30" Deep
- 36" Deep



Work Bench with Stringer and Shelf

48"W	60"W	72"W	84"W	96"W
B-304S-1	B-305S-1	B-306S-1	B-307S-1	B-308S-1
B-364S-1	B-365S-1	B-366S-1	B-367S-1	B-368S-1
B-304SS-1	B-305SS-1	B-306SS-1	B-307SS-1	B-308SS-1
B-364SS-1	B-365SS-1	B-366SS-1	B-367SS-1	B-368SS-1
B-304M-1	B-305M-1	B-306M-1	B-307M-1	B-308M-1
B-364M-1	B-365M-1	B-366M-1	B-367M-1	B-368M-1
B-304L-1	B-305L-1	B-306L-1	B-307L-1	B-308L-1
B-364L-1	B-365L-1	B-366L-1	B-367L-1	B-368L-1
B-304LE-1	B-305LE-1	B-306LE-1	B-307LE-1	B-308LE-1
B-364LE-1	B-365LE-1	B-366LE-1	B-367LE-1	B-368LE-1
B-304R-1	B-305R-1	B-306R-1	B-307R-1	B-308R-1
B-364R-1	B-365R-1	B-366R-1	B-367R-1	B-368R-1

Leg height: 34"

Add top thickness for O.A. height

For Mobile 5" Caster Kit Option:

Add ".P" to the Part Number

Work Surface Type

S	2" Pan Folded 12 Gauge Steel Top	L	1-1/4" Plastic Laminate Top with Spray Applied Edging
SS	1-1/2" 16 Gauge Formed Stainless Steel w/ Wood Core	LE	1-1/4" ESD Plastic Laminate Top w/ Sprayed Armor Edge
M	1-3/4" Hardwood/Maple Top	R	1" Epoxy Resin Top - Maximum Chemical Resistance

For 11 Gauge HD Leg Construction Add .HD to the Part Number



Work Bench with Stringer, DT-9 9" Drawer

48"W	60"W	72"W	84"W	96"W
B-304S-2	B-305S-2	B-306S-2	B-307S-2	B-308S-2
B-364S-2	B-365S-2	B-366S-2	B-367S-2	B-368S-2
B-304SS-2	B-305SS-2	B-306SS-2	B-307SS-2	B-308SS-2
B-364SS-2	B-365SS-2	B-366SS-2	B-367SS-2	B-368SS-2
B-304M-2	B-305M-2	B-306M-2	B-307M-2	B-308M-2
B-364M-2	B-365M-2	B-366M-2	B-367M-2	B-368M-2
B-304L-2	B-305L-2	B-306L-2	B-307L-2	B-308L-2
B-364L-2	B-365L-2	B-366L-2	B-367L-2	B-368L-2
B-304LE-2	B-305LE-2	B-306LE-2	B-307LE-2	B-308LE-2
B-364LE-2	B-365LE-2	B-366LE-2	B-367LE-2	B-368LE-2
B-304R-2	B-305R-2	B-306R-2	B-307R-2	B-308R-2
B-364R-2	B-365R-2	B-366R-2	B-367R-2	B-368R-2

- 30" Deep
- 36" Deep



Work Bench with Stringer and Shelf, DT-9 9" Drawer

48"W	60"W	72"W	84"W	96"W
B-304S-12	B-305S-12	B-306S-12	B-307S-12	B-308S-12
B-364S-12	B-365S-12	B-366S-12	B-367S-12	B-368S-12
B-304SS-12	B-305SS-12	B-306SS-12	B-307SS-12	B-308SS-12
B-364SS-12	B-365SS-12	B-366SS-12	B-367SS-12	B-368SS-12
B-304M-12	B-305M-12	B-306M-12	B-307M-12	B-308M-12
B-364M-12	B-365M-12	B-366M-12	B-367M-12	B-368M-12
B-304L-12	B-305L-12	B-306L-12	B-307L-12	B-308L-12
B-364L-12	B-365L-12	B-366L-12	B-367L-12	B-368L-12
B-304LE-12	B-305LE-12	B-306LE-12	B-307LE-12	B-308LE-12
B-364LE-12	B-365LE-12	B-366LE-12	B-367LE-12	B-368LE-12
B-304R-12	B-305R-12	B-306R-12	B-307R-12	B-308R-12
B-364R-12	B-365R-12	B-366R-12	B-367R-12	B-368R-12



Adj. Work Bench with Stringer

48"W	60"W	72"W	84"W	96"W
BA-304S	BA-305S	BA-306S	BA-307S	BA-308S
BA-364S	BA-365S	BA-366S	BA-367S	BA-368S
BA-304SS	BA-305SS	BA-306SS	BA-307SS	BA-308SS
BA-364SS	BA-365SS	BA-366SS	BA-367SS	BA-368SS
BA-304M	BA-305M	BA-306M	BA-307M	BA-308M
BA-364M	BA-365M	BA-366M	BA-367M	BA-368M
BA-304L	BA-305L	BA-306L	BA-307L	BA-308L
BA-364L	BA-365L	BA-366L	BA-367L	BA-368L
BA-304LE	BA-305LE	BA-306LE	BA-307LE	BA-308LE
BA-364LE	BA-365LE	BA-366LE	BA-367LE	BA-368LE
BA-304R	BA-305R	BA-306R	BA-307R	BA-308R
BA-364R	BA-365R	BA-366R	BA-367R	BA-368R



Adj. Work Bench with Stringer and Shelf

48"W	60"W	72"W	84"W	96"W
BA-304S-1	BA-305S-1	BA-306S-1	BA-307S-1	BA-308S-1
BA-364S-1	BA-365S-1	BA-366S-1	BA-367S-1	BA-368S-1
BA-304SS-1	BA-305SS-1	BA-306SS-1	BA-307SS-1	BA-308SS-1
BA-364SS-1	BA-365SS-1	BA-366SS-1	BA-367SS-1	BA-368SS-1
BA-304M-1	BA-305M-1	BA-306M-1	BA-307M-1	BA-308M-1
BA-364M-1	BA-365M-1	BA-366M-1	BA-367M-1	BA-368M-1
BA-304L-1	BA-305L-1	BA-306L-1	BA-307L-1	BA-308L-1
BA-364L-1	BA-365L-1	BA-366L-1	BA-367L-1	BA-368L-1
BA-304LE-1	BA-305LE-1	BA-306LE-1	BA-307LE-1	BA-308LE-1
BA-364LE-1	BA-365LE-1	BA-366LE-1	BA-367LE-1	BA-368LE-1
BA-304R-1	BA-305R-1	BA-306R-1	BA-307R-1	BA-308R-1
BA-364R-1	BA-365R-1	BA-366R-1	BA-367R-1	BA-368R-1

30" Deep
36" Deep
12 Gauge Steel
16GA Stainless Steel
Hardwood
Plastic Laminate
ESD Laminate
Epoxy Resin

Leg height: 27" TO 36"
Add top thickness for O.A. height

For Mobile 5" Caster Kit Option:
Add ".P" to the Part Number

Work Surface Type

S	2" Pan Folded 12 Gauge Steel Top	L	1-1/4" Plastic Laminate Top with Spray Applied Edging
SS	1-1/2" 16 Gauge Formed Stainless Steel w/ Wood Core	LE	1-1/4" ESD Plastic Laminate Top w/ Sprayed Armor Edge
M	1-3/4" Hardwood/Maple Top	R	1" Epoxy Resin Top - Maximum Chemical Resistance

For 11 Gauge HD Leg Construction Add .HD to the Part Number



Adj. Work Bench with Stringer, DT-9 9" Drawer

48"W	60"W	72"W	84"W	96"W
BA-304S-2	BA-305S-2	BA-306S-2	BA-307S-2	BA-308S-2
BA-364S-2	BA-365S-2	BA-366S-2	BA-367S-2	BA-368S-2
BA-304SS-2	BA-305SS-2	BA-306SS-2	BA-307SS-2	BA-308SS-2
BA-364SS-2	BA-365SS-2	BA-366SS-2	BA-367SS-2	BA-368SS-2
BA-304M-2	BA-305M-2	BA-306M-2	BA-307M-2	BA-308M-2
BA-364M-2	BA-365M-2	BA-366M-2	BA-367M-2	BA-368M-2
BA-304L-2	BA-305L-2	BA-306L-2	BA-307L-2	BA-308L-2
BA-364L-2	BA-365L-2	BA-366L-2	BA-367L-2	BA-368L-2
BA-304LE-2	BA-305LE-2	BA-306LE-2	BA-307LE-2	BA-308LE-2
BA-364LE-2	BA-365LE-2	BA-366LE-2	BA-367LE-2	BA-368LE-2
BA-304R-2	BA-305R-2	BA-306R-2	BA-307R-2	BA-308R-2
BA-364R-2	BA-365R-2	BA-366R-2	BA-367R-2	BA-368R-2



Adj. Work Bench with Stringer and Shelf, DT-9 9" Drawer

48"W	60"W	72"W	84"W	96"W
BA-304S-12	BA-305S-12	BA-306S-12	BA-307S-12	BA-308S-12
BA-364S-12	BA-365S-12	BA-366S-12	BA-367S-12	BA-368S-12
BA-304SS-12	BA-305SS-12	BA-306SS-12	BA-307SS-12	BA-308SS-12
BA-364SS-12	BA-365SS-12	BA-366SS-12	BA-367SS-12	BA-368SS-12
BA-304M-12	BA-305M-12	BA-306M-12	BA-307M-12	BA-308M-12
BA-364M-12	BA-365M-12	BA-366M-12	BA-367M-12	BA-368M-12
BA-304L-12	BA-305L-12	BA-306L-12	BA-307L-12	BA-308L-12
BA-364L-12	BA-365L-12	BA-366L-12	BA-367L-12	BA-368L-12
BA-304LE-12	BA-305LE-12	BA-306LE-12	BA-307LE-12	BA-308LE-12
BA-364LE-12	BA-365LE-12	BA-366LE-12	BA-367LE-12	BA-368LE-12
BA-304R-12	BA-305R-12	BA-306R-12	BA-307R-12	BA-308R-12
BA-364R-12	BA-365R-12	BA-366R-12	BA-367R-12	BA-368R-12

30" Deep
36" Deep
12 Gauge Steel
16GA Stainless Steel
Hardwood
Plastic Laminate
ESD Laminate
Epoxy Resin



Adj. Work Bench with Stringer

48"W	60"W	72"W	84"W	96"W
BT-304S	BT-305S	BT-306S	BT-307S	BT-308S
BT-364S	BT-365S	BT-366S	BT-367S	BT-368S
BT-304SS	BT-305SS	BT-306SS	BT-307SS	BT-308SS
BT-364SS	BT-365SS	BT-366SS	BT-367SS	BT-368SS
BT-304M	BT-305M	BT-306M	BT-307M	BT-308M
BT-364M	BT-365M	BT-366M	BT-367M	BT-368M
BT-304L	BT-305L	BT-306L	BT-307L	BT-308L
BT-364L	BT-365L	BT-366L	BT-367L	BT-368L
BT-304LE	BT-305LE	BT-306LE	BT-307LE	BT-308LE
BT-364LE	BT-365LE	BT-366LE	BT-367LE	BT-368LE
BT-304R	BT-305R	BT-306R	BT-307R	BT-308R
BT-364R	BT-365R	BT-366R	BT-367R	BT-368R

30" Deep
36" Deep



Adj. Work Bench with Stringer and Shelf

48"W	60"W	72"W	84"W	96"W
BT-304S-1	BT-305S-1	BT-306S-1	BT-307S-1	BT-308S-1
BT-364S-1	BT-365S-1	BT-366S-1	BT-367S-1	BT-368S-1
BT-304SS-1	BT-305SS-1	BT-306SS-1	BT-307SS-1	BT-308SS-1
BT-364SS-1	BT-365SS-1	BT-366SS-1	BT-367SS-1	BT-368SS-1
BT-304M-1	BT-305M-1	BT-306M-1	BT-307M-1	BT-308M-1
BT-364M-1	BT-365M-1	BT-366M-1	BT-367M-1	BT-368M-1
BT-304L-1	BT-305L-1	BT-306L-1	BT-307L-1	BT-308L-1
BT-364L-1	BT-365L-1	BT-366L-1	BT-367L-1	BT-368L-1
BT-304LE-1	BT-305LE-1	BT-306LE-1	BT-307LE-1	BT-308LE-1
BT-364LE-1	BT-365LE-1	BT-366LE-1	BT-367LE-1	BT-368LE-1
BT-304R-1	BT-305R-1	BT-306R-1	BT-307R-1	BT-308R-1
BT-364R-1	BT-365R-1	BT-366R-1	BT-367R-1	BT-368R-1

Leg height 27" TO 36"
Add top thickness for O.A. height

For Mobile 5" Caster Kit Option:
Add ".P" to the Part Number

Work Surface Type

S	2" Pan Folded 12 Gauge Steel Top	L	1-1/4" Plastic Laminate Top with Spray Applied Edging
SS	1-1/2" 16 Gauge Formed Stainless Steel w/ Wood Core	LE	1-1/4" ESD Plastic Laminate Top w/ Sprayed Armor Edge
M	1-3/4" Hardwood/Maple Top	R	1" Epoxy Resin Top - Maximum Chemical Resistance

For 11 Gauge HD Leg Construction Add .HD to the Part Number



Adj. Work Bench with Stringer, DT-9 9" Drawer

48"W	60"W	72"W	84"W	96"W
BT-304S-2	BT-305S-2	BT-306S-2	BT-307S-2	BT-308S-2
BT-364S-2	BT-365S-2	BT-366S-2	BT-367S-2	BT-368S-2
BT-304SS-2	BT-305SS-2	BT-306SS-2	BT-307SS-2	BT-308SS-2
BT-364SS-2	BT-365SS-2	BT-366SS-2	BT-367SS-2	BT-368SS-2
BT-304M-2	BT-305M-2	BT-306M-2	BT-307M-2	BT-308M-2
BT-364M-2	BT-365M-2	BT-366M-2	BT-367M-2	BT-368M-2
BT-304L-2	BT-305L-2	BT-306L-2	BT-307L-2	BT-308L-2
BT-364L-2	BT-365L-2	BT-366L-2	BT-367L-2	BT-368L-2
BT-304LE-2	BT-305LE-2	BT-306LE-2	BT-307LE-2	BT-308LE-2
BT-364LE-2	BT-365LE-2	BT-366LE-2	BT-367LE-2	BT-368LE-2
BT-304R-2	BT-305R-2	BT-306R-2	BT-307R-2	BT-308R-2
BT-364R-2	BT-365R-2	BT-366R-2	BT-367R-2	BT-368R-2

30" Deep
36" Deep



Adj. Work Bench with Stringer and Shelf, DT-9 9" Drawer

48"W	60"W	72"W	84"W	96"W
BT-304S-12	BT-305S-12	BT-306S-12	BT-307S-12	BT-308S-12
BT-364S-12	BT-365S-12	BT-366S-12	BT-367S-12	BT-368S-12
BT-304SS-12	BT-305SS-12	BT-306SS-12	BT-307SS-12	BT-308SS-12
BT-364SS-12	BT-365SS-12	BT-366SS-12	BT-367SS-12	BT-368SS-12
BT-304M-12	BT-305M-12	BT-306M-12	BT-307M-12	BT-308M-12
BT-364M-12	BT-365M-12	BT-366M-12	BT-367M-12	BT-368M-12
BT-304L-12	BT-305L-12	BT-306L-12	BT-307L-12	BT-308L-12
BT-364L-12	BT-365L-12	BT-366L-12	BT-367L-12	BT-368L-12
BT-304LE-12	BT-305LE-12	BT-306LE-12	BT-307LE-12	BT-308LE-12
BT-364LE-12	BT-365LE-12	BT-366LE-12	BT-367LE-12	BT-368LE-12
BT-304R-12	BT-305R-12	BT-306R-12	BT-307R-12	BT-308R-12
BT-364R-12	BT-365R-12	BT-366R-12	BT-367R-12	BT-368R-12



Work Station With Front Power Apron

Open base constructed of 14 gauge steel - Adjustable height leg base from 27" to 36" - Rear lower leg stringer - 1-3/4" hardwood maple top - (1) power apron with (7) 110V outlets - Lighted on/off switch - 6' cord and plug.

24"D	Size
GP-625	24"D x 60"W Hardwood Top
GP-626	24"D x 72"W Hardwood Top
GP-627	24"D x 84"W Hardwood Top
GP-628	24"D x 96"W Hardwood Top

30"D	Size
GP-635	30"D x 60"W Hardwood Top
GP-636	30"D x 72"W Hardwood Top
GP-637	30"D x 84"W Hardwood Top
GP-638	30"D x 96"W Hardwood Top



Work Station With Rear Power Apron

Open base constructed of 14 gauge steel - Adjustable height leg base from 27" to 36" - Rear lower leg stringer - 1-3/4" hardwood maple top - (1) power apron with (7) 110V outlets - Lighted on/off switch - 6' cord and plug.

24"D	Size
GP-725	24"D x 60"W Hardwood Top
GP-726	24"D x 72"W Hardwood Top
GP-727	24"D x 84"W Hardwood Top
GP-728	24"D x 96"W Hardwood Top

30"D	Size
GP-735	30"D x 60"W Hardwood Top
GP-736	30"D x 72"W Hardwood Top
GP-737	30"D x 84"W Hardwood Top
GP-738	30"D x 96"W Hardwood Top



Work Station With Front and Rear Power Aprons

Open base constructed of 14 gauge steel - Adjustable height leg base from 27" to 36" - Rear lower leg stringer - 1-3/4" hardwood maple top - (2) power aprons with (7) 110V outlets - Lighted on/off switch - 6' cord and plug.

24"D	Size
GP-825	24"D x 60"W Hardwood Top
GP-826	24"D x 72"W Hardwood Top
GP-827	24"D x 84"W Hardwood Top
GP-828	24"D x 96"W Hardwood Top

30"D	Size
GP-835	30"D x 60"W Hardwood Top
GP-836	30"D x 72"W Hardwood Top
GP-837	30"D x 84"W Hardwood Top
GP-838	30"D x 96"W Hardwood Top



Work Station With Riser Shelf

Open base constructed of 14 gauge steel - Adjustable height leg base from 27" to 36" - Rear lower leg stringer - 1-3/4" hardwood maple top - (2) power aprons with (7) 120V/15 amp outlets - Lighted on/off switch - 6' cords with plug - 12"h x 12"d rear riser with 1-3/4" hardwood maple shelf.

24"D	Size
GP-925	24"D x 60"W Hardwood Top
GP-926	24"D x 72"W Hardwood Top
GP-927	24"D x 84"W Hardwood Top
GP-928	24"D x 96"W Hardwood Top

30"D	Size
GP-935	30"D x 60"W Hardwood Top
GP-936	30"D x 72"W Hardwood Top
GP-937	30"D x 84"W Hardwood Top
GP-938	30"D x 96"W Hardwood Top



PCA Portable Work Station

Portable work bench with integrated rear power apron. Work surface is a durable 1-3/4" thick hardwood maple, with bull nose front edge. Welded leg assembly is made from 1" x 2" tube steel frame with steel panel insert and 4" locking stem casters. Work surface height is 29.50".

Part #	Size
PCA-4830-M-P	30"D x 48"W - Mobile
PCA-6030-M-P	30"D x 60"W - Mobile
PCA-7230-M-P	30"D x 72"W - Mobile
Note: For stationary bench remove "-P" from part number.	



Height Adjustable Formed Channel Leg
Formed 12 & 14 gauge steel channel leg with galvanized adjustable leg insert - All welded assembly - Height adjusts from 27" to 36" on 1" centers.

For 24" d Tops	For 30" d Tops	For 36" d Tops
BAL-24	BAL-30	BAL-36



Steel Riser Shelf
Assembly measures 16"H x 14"D - Solid 16 gauge steel - Includes riser uprights and metal shelf - 2" high rear back stop.

Part #	Description
BRS-16-48	48"W x 10"D x 16"H Riser Shelf
BRS-16-60	60"W x 10"D x 16"H Riser Shelf
BRS-16-72	72"W x 10"D x 16"H Riser Shelf
BRS-16-84	84"W x 10"D x 16"H Riser Shelf
BRS-16-96	96"W x 10"D x 16"H Riser Shelf



Fixed Height Riser Shelf Supports
Constructed from formed 14 gauge steel 12"H uprights - Riser kit includes (2) supports and rear stringer - Designed for 12"D shelf - Shelf sold separately.

Part #	Description
BFR-12-48	48"W x 10"D x 12"H Riser Kit
BFR-12-60	60"W x 10"D x 12"H Riser Kit
BFR-12-72	72"W x 10"D x 12"H Riser Kit
BFR-12-84	84"W x 10"D x 12"H Riser Kit
BFR-12-96	96"W x 10"D x 12"H Riser Kit



Fixed Height Formed Channel Leg
Formed 12 & 14 gauge steel channel leg - All welded assembly - Height 34".

For 24" d Tops	For 30" d Tops	For 36" d Tops
BL-24	BL-30	BL-36



Steel Lower Shelf
Assembly measures 14" deep and is constructed from 16 gauge steel - 2"H rear back support - Fits all formed channel steel legs.

Part #	Description
BLS-48	Fits 48"W Bench - Lower Shelf
BLS-60	Fits 60"W Bench - Lower Shelf
BLS-72	Fits 72"W Bench - Lower Shelf
BLS-84	Fits 84"W Bench - Lower Shelf
BLS-96	Fits 96"W Bench - Lower Shelf



Caster Option
Add casters to your B-Series work stations - Caster kits come with (2) 5" rigid and (2) 5" swivel w/ brake - Casters are rated for 300 lbs per wheel - Optional caster kits must be ordered with workstations.

B-Fixed Ht	BA-ADJ Ht	BT-ADJ Ht
B-CST-5	BA-CST-5	BT-CST-5



Adjustable Height Tubular Steel Leg
2" x 14 gauge steel tubing leg - All welded assembly - Height adjusts from 27" to 36" on 1" centers.

For 24" d Tops	For 30" d Tops	For 36" d Tops
BT-24	BT-30	BT-36



Leg Stringer
Constructed from 12 gauge steel - 4"H stringer back support bolts to leg base - Fits all steel legs.

Part #	Description
BS-48	Fits 48"W Bench - Stringer
BS-60	Fits 60"W Bench - Stringer
BS-72	Fits 72"W Bench - Stringer
BS-84	Fits 84"W Bench - Stringer
BS-96	Fits 96"W Bench - Stringer



DTP-9PL 9" Drawer Shown

Storage Drawers
Individual storage drawers are available in three height options - Drawer features ball bearing 125 lb glides - Plastic recessed handle - Padlock hasp - Drawers are 16"W x 20"D.

6"h Drawer	9"h Drawer	12"h Drawer
DTP-6PL	DTP-9PL	DTP-12PL

See Pages 136-139 for Additional Accessories

Tear Down Bench

Work bench is designed for small engine and transmission work where oil and fluids can be a problem. All welded construction of heavy gauge steel. Perforated galvanized steel work surface with lower drain pan. Lower shelf measures 14"D with a 2 gallon oil/fluid container. 3" high back and end stops around work surface. Adjustable height legs from 27" to 36"H.



Part #	Size
BA-305-TDB-GALV	30"D x 60"W Perforated Top
BA-306-TDB-GALV	30"D x 72"W Perforated Top
BA-365-TDB-GALV	36"D x 60"W Perforated Top
BA-366-TDB-GALV	36"D x 72"W Perforated Top

Extreme Duty Tables

Extreme Duty work benches are designed for heavy fabrication and work loads. The base is constructed from 3-1/2" diameter, heavy wall steel tubing uprights. The 3/8" solid steel plate top is supported with a 1/2" x 2" all welded support frame that is integrated into the leg uprights for maximum strength. Work benches are equipped standard with a fixed lower shelf constructed of 3/16 steel plate top and under frame support. Includes floor anchor pads with 5/8" diameter floor anchor hole. All welded construction.



Up to 10,000 Lb.
Capacity

30" Deep Tables

Part #	Description
EX-3048	30"D x 48"W x 40"H Work Bench
EX-3060	30"D x 60"W x 40"H Work Bench
EX-3072	30"D x 72"W x 40"H Work Bench
EX-3084	30"D x 84"W x 40"H Work Bench
EX-3096	30"D x 96"W x 40"H Work Bench

36" Deep Tables

Part #	Description
EX-3648	36"D x 48"W x 40"H Work Bench
EX-3660	36"D x 60"W x 40"H Work Bench
EX-3672	36"D x 72"W x 40"H Work Bench
EX-3684	36"D x 84"W x 40"H Work Bench
EX-3696	36"D x 96"W x 40"H Work Bench

Extreme Duty Stands

Extreme Duty Stands are designed for the toughest applications and heaviest loads. Stands have a capacity up to 20,000 lbs and can be used to support large dies or fabrication projects. The base is constructed of 3" square tubular steel with a 3/8" wall thickness. The top rail is a heavy 3" "I" beam. Floor anchor pads are 1/2" thick with 5/8" diameter floor anchor hole. All welded construction. Special sizes and configurations are available.



Up to 20,000 Lb.
Capacity

24" High Stands

Part #	Description
EXS-2424	24"D x 24"W x 24"H Work Stand
EXS-2430	24"D x 30"W x 24"H Work Stand
EXS-2436	24"D x 36"W x 24"H Work Stand
EXS-2448	24"D x 48"W x 24"H Work Stand

30" High Stands

Part #	Description
EXS-3024	24"D x 24"W x 30"H Work Stand
EXS-3030	24"D x 30"W x 30"H Work Stand
EXS-3036	24"D x 36"W x 30"H Work Stand
EXS-3048	24"D x 48"W x 30"H Work Stand



Heavy Duty Workbench

All welded workbenches are built to hold heavy loads and last a life-time - Legs are constructed of 1/4" thick 2" x 2" angle steel with floor anchor pads - Welded lower storage shelf - Heavy 7 gauge steel top is reinforced to hold loads up to 10,000lbs - 84"W table requires 6 legs.

	Depth	48"W	60"W	72"W	84"W
36"H	30"	EXW-304-1	EXW-305-1	EXW-306-1	EXW-307-1
	36"	EXW-364-1	EXW-365-1	EXW-366-1	EXW-367-1



Heavy Duty Workbench w/ Drawers

All welded workbench, built to hold heavy loads - Legs are constructed of 1/4" thick 2" x 2" angle steel with floor anchor pads - Welded lower shelf - (2) 6"H half width drawers mounted on 250lb full extension glides - Padlocking hasps to secure contents - Heavy 7 gauge steel top is reinforced to hold loads up to 10,000lbs - 84"W table requires 6 legs.

	Depth	48"W	60"W	72"W	84"W
36"H	30"	EXW-304-1-2D	EXW-305-1-2D	EXW-306-1-2D	EXW-307-1-2D
	36"	EXW-364-1-2D	EXW-365-1-2D	EXW-366-1-2D	EXW-367-1-2D



Adjustable Height Bench

This versatile adjustable height bench can accommodate everyone and provide a heavy duty bench for all situations - The 12GA steel legs are adjustable in 2" increments and adjust from 30"H to 40"H - Welded lower storage shelf - Heavy 7 gauge steel top is reinforced to hold loads up to 8,000lbs.

Depth	Adj. Height	48"W	60"W	72"W
30"	30"H - 40"H	EXW-304-ADJ	EXW-305-ADJ	EXW-306-ADJ
36"	30"H - 40"H	EXW-364-ADJ	EXW-365-ADJ	EXW-366-ADJ



Double Door / Drawer Workbench

All welded 12 gauge steel construction - Hardwood maple worksurface with 2.25"H retaining rail on three sides - Double door lower section with (1) adjustable height shelf - (2) padlocking 6"H half width drawers mounted on 250lb full extension glides - 3 point door lock with heavy duty steel padlocking handle - Welded on hinges.

Size	Model Number	Doors	Drawer
48"W x 30"D x 37.75"H	EXW-4830-2D2DW	2	(2) 6"H
60"W x 30"D x 37.75"H	EXW-6030-2D2DW	2	(2) 4"H
72"W x 30"D x 37.75"H	EXW-7230-2D2DW	2	(2) 6"H



3 Compartment Workbench

All welded 12GA steel construction - 38"H Steel work surface - Three individual lower compartments w/ (2) adjustable height shelves in each - Welded on door hinges - Secure 3 point locking door system with solid steel handles & padlock hasps - 12"H Rear organizer shelf - 6"H legs.

Size	Model Number	Drawers	Doors
60"W x 30"D x 50"H	EXW-6030-3DS	0	3
72"W x 30"D x 50"H	EXW-7230-3DS	0	3
84"W x 30"D x 50"H	EXW-8430-3DS	0	3
96"W x 30"D x 50"H	EXW-9630-3DS	0	3



3 Compartment Workbench w/ Drawers

All welded 12GA steel construction - 38"H Steel work surface - Welded on door hinges - Three individual lower compartments w/ (1) adjustable height shelf and (1) 6"H drawer in each - 3 point locking system with solid steel handles & padlock hasps - Drawer mounted on 250lb glides - 12"H Rear organizer shelf - 6"H legs.

Size	Model Number	Drawers	Doors
60"W x 30"D x 50"H	EXW-6030-3DSD	3	3
72"W x 30"D x 50"H	EXW-7230-3DSD	3	3
84"W x 30"D x 50"H	EXW-8430-3DSD	3	3
96"W x 30"D x 50"H	EXW-9630-3DSD	3	3



Double Door Bench w/ Overhead Storage

All welded 12ga steel construction - 38"H Steel work surface - Double door lower compartments w/ (1) adjustable height shelf - Rear hutch provides 16"H x 12"D additional storage areas - Welded on door hinges - Secure 3 point locking door system with solid steel handles & padlock hasps - 6"H legs.

Size	Model Number	Description
60"W x 30"D x 66"H	EXW-6030-2DOS	60"W Workstation w/ hutch
72"W x 30"D x 66"H	EXW-7230-2DOS	72"W Workstation w/ hutch
84"W x 30"D x 66"H	EXW-8430-2DOS	84"W Workstation w/ hutch



Double Door General Storage Bench

All welded 12 gauge steel construction - 1.75"H hardwood maple work surface - Double door lower section with (1) adjustable height shelf provides general storage of tools and supplies - 3 point door lock with heavy duty steel padlocking handle - Welded on hinges.

	Depth	48"W	60"W	72"W	84"W
37.75"H	30"	EXW-4830-2D-M	EXW-6030-2D-M	EXW-7230-2D-M	EXW-8430-2D-M
	36"	EXW-4836-2D-M	EXW-6036-2D-M	EXW-7236-2D-M	EXW-8436-2D-M

Dura-Flex accessories allow you to create a workstation to fit your exact application. The Dura-Flex back supports and accessories will fit on a variety of our open leg, IHL, and Dura-Tech series workbenches. Choose from pre-configured selections or configure your own simply by adding the Dura-Flex back support frames to any 60" or 72" station. Then select the accessories you need to organize and enhance the ergonomics of your work area.

Ideal Uses

- Assembly Work Stations
- Technical/Repair Work Benches
- Shipping And Receiving Stations

Dura-Flex Configuration Seven



Model: DTL-6AD-DTFX-CFG7-72

Dura-Flex Configuration Eight



Model: DTL-3628-0400-BTL-SH-DTFX-CFG8-72

Dura-Flex back support uprights and frames offer maximum flexibility in mounting components.



Adding a power apron strip conveniently puts outlets right at the work station.



Tool panels and plastic bin rails will keep your work station stocked and organized.





Configuration One

- Upright Frame Assembly
- (1) Overhead Light Assembly
- (1) 120V x 15 amp Power Apron

Part Number	Description
DTFX-CFG1-60	Configuration 1 for a 60"W Work Surface
DTFX-CFG1-72	Configuration 1 for a 72"W Work Surface

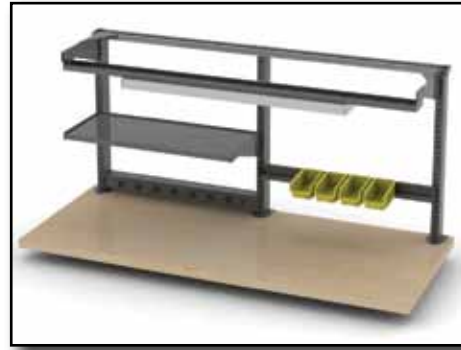

Configuration Two

- Upright Frame Assembly
- (1) 120V x 15 amp Power Apron
- (1) Bin Rail with (4) Small Bins
- Overhead Light Assembly
- (1) Adjustable Storage Shelf

Part Number	Description
DTFX-CFG2-60	Configuration 2 for a 60"W Work Surface
DTFX-CFG2-72	Configuration 2 for a 72"W Work Surface

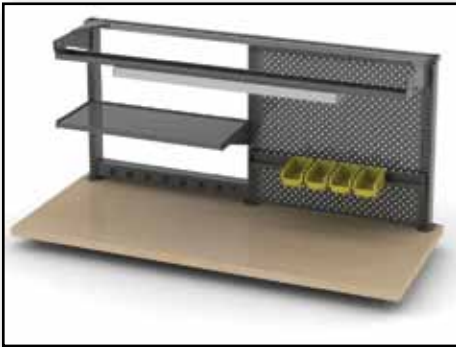

Configuration Three

- Upright Frame Assembly
- (1) 120V x 15 amp Power Apron
- (1) Bin Rail with (4) Small Bins
- Overhead Light Assembly
- (1) Adjustable Storage Shelf
- (1) Metal Tool Panel

Part Number	Description
DTFX-CFG3-60	Configuration 3 for a 60"W Work Surface
DTFX-CFG3-72	Configuration 3 for a 72"W Work Surface



Configuration Four

- Upright Frame Assembly
- (1) 120V x 15 amp Power Apron
- (1) Bin Rail with (4) Small Bins
- Overhead Light Assembly
- (2) Adjustable Storage Shelves

Part Number	Description
DTFX-CFG4-60	Configuration 4 for a 60"W Work Surface
DTFX-CFG4-72	Configuration 4 for a 72"W Work Surface



Configuration Five

- Upright Frame Assembly
- Overhead Light Assembly
- (1) Bin Rail with (4) Small Bins
- Tool Rail
- (2) Adjustable Storage Shelves
- Tool Trolley
- (1) 120V x 15 amp Power Apron

Part Number	Description
DTFX-CFG5-60	Configuration 5 for a 60"W Work Surface
DTFX-CFG5-72	Configuration 5 for a 72"W Work Surface

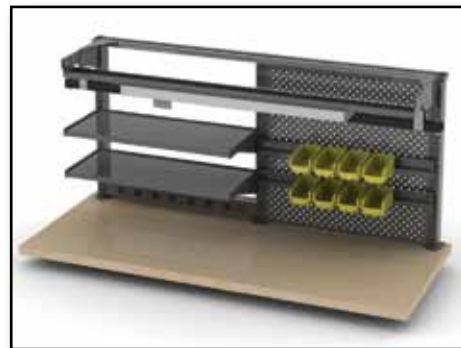

Configuration Six

- Upright Frame Assembly
- (1) 120V x 15 amp Power Apron
- (1) Metal Tool Panel
- Overhead Light Assembly
- (2) Bin Rails with (8) Small Bins
- Tool Rail
- (2) Adjustable Storage Shelves
- Tool Trolley

Part Number	Description
DTFX-CFG6-60	Configuration 6 for a 60"W Work Surface
DTFX-CFG6-72	Configuration 6 for a 72"W Work Surface



Dura-Flex Back Support Frames

Base uprights are notched front and back to allow accessories to be mounted to both sides - Uprights are available in a variety of heights - Bases mount to rear of work surface.

- Includes (3) Upright Supports
- (2) Top Rail Supports
- Mounting Plates
- Top Rail End Caps

Part #	Height	Fits Benches	Description
DTFX-60-30	30"	60" Wide	Dura-Flex Back Upright Support Frame
DTFX-60-34	34"	60" Wide	Dura-Flex Back Upright Support Frame
DTFX-60-39	39"	60" Wide	Dura-Flex Back Upright Support Frame
DTFX-72-30	30"	72" Wide	Dura-Flex Back Upright Support Frame
DTFX-72-34	34"	72" Wide	Dura-Flex Back Upright Support Frame
DTFX-72-39	39"	72" Wide	Dura-Flex Back Upright Support Frame

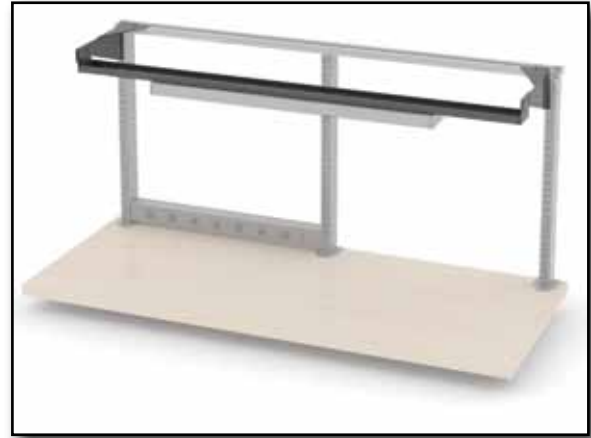

Light Bar

Use for overhead task lighting - Mounts to back supports - 48" LED task light included - Light only for hardwire applications - Cord and switch includes 9' power cord and on/off switch.

- 48" Task Light
- (2) Light Support Arms
- Light Mounting Rail
- Hardwire or Cord and Plug Option

Part #	Fits Benches	Description
DTFXL-60	60" Wide	Dura-Flex Light For 60" Table - Hardwire
DTFXL-72	72" Wide	Dura-Flex Light For 72" Table - Hardwire
DTFXL-60A	60" Wide	Dura-Flex Light For 60" Table - Cord and Plug
DTFXL-72A	72" Wide	Dura-Flex Light For 72" Table - Cord and Plug

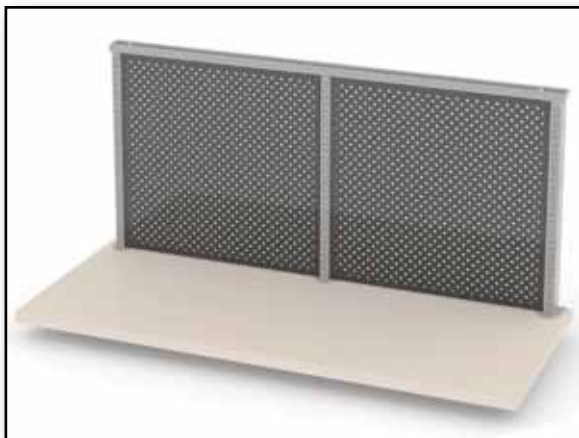

Tool Panel

Tool panel frame mounts to rear of back support frame - Tool boards are available in metal or 1/4" tempered hardboard - Standard hole pattern - Tool hanger kits sold separately.

- Offered in 1/4" Hardboard or Metal
- Standard Hole Pattern
- For 60" and 72" Dura-Flex Uprights
- Custom Configurations Available

Part #	Material	Fits Benches	Description
DTBF-PG-60	Hardboard	60"	30"W x 30"H Pegboard Tool Panel
DTBF-PG-72	Hardboard	72"	36"W x 30"H Pegboard Tool Panel
DTBF-PG-60-STL	Steel	60"	30"W x 30"H Steel Tool Panel
DTBF-PG-72-STL	Steel	72"	36"W x 30"H Steel Tool Panel

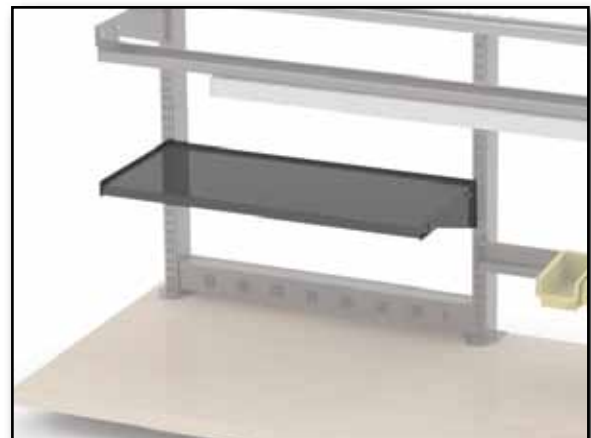

Utility Shelf

12" deep shelf mounts to Dura-Flex back frame - Reversible bracket allows shelf to be mounted at a 0 or 15 degree slant - 16 gauge steel.

- Steel Shelf
- Reversible Mounting Bracket
- Standard 12" Depth
- 50 lb Capacity

Part #	Fits Benches	Description
DFXBS-30	60" Wide	30"W x 12"D Utility Shelf
DFXBS-36	72" Wide	36"W x 12"D Utility Shelf



Power Apron

Universal power aprons measure 4"H - Aprons can be used with Dura-Flex or mount directly to work surface - Provides (6) 120V-15 amp outlets with a lighted on/off switch - Provided with a 6' cord & plug.

- Universal Mounting
- Six 120V x 15 amp Outlets
- 6' Cord and Plug
- Lighted On/Off Switch

Part #	Description	Part #	Description
DTPA-30	30" Power Apron	DTPA-60	60" Power Apron
DTPA-36	36" Power Apron	DTPA-72	72" Power Apron
DTPA-48	48" Power Apron	DTPA-84	84" Power Apron

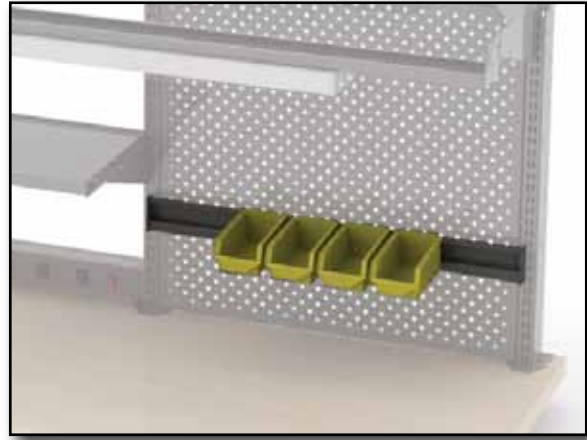

Plastic Bin Rail/Bins

Bin rails mount between Dura-Flex uprights - One bin rail will accommodate a single row of standard plastic hanging bins - See chart below for number of bins allowable per rail.

- Holds 4" and 6" Bins
- Fits 60" and 72" Frames
- One Rail Per Row on Bins
- Bins Sold Separately

Part #	Fits Upright Frame	4"W Bins	6"W Bins	Description
DFXR-105-60	60" Frame	6	4	Bin Rail for Dura-Flex
DFXR-105-72	72" Frame	7	5	Bin Rail for Dura-Flex

Plastic Bins - Additional bin sizes available. Contact GMI for details.

Part #	Size	Description
DFXB-442	4.125"W x 7.375"D x 3"H	Plastic Bin
DFXB-695	5.50"W x 10.875"D x 5"H	Plastic Bin



Tool Trolley Rail

Tool rail provides a trolley to suspend tools above the work surface and to allow lateral movement along the length of the station - Mount assembly attaches to upper back support.

- 45 lb Weight Capacity
- Roller Bearing Glides
- Support Mounts Sold Separately
- Works with Light Bar Option

Part #	Fits Frame	Description
DFXTR-60	60" Wide	Tool Rail with Trolley
DFXTR-72	72" Wide	Tool Rail with Trolley
DFXTR-MNT	All	Tool Rail Mounting Supports - Not Required With Task Light



Tool Tray

Use for holding tools at the ready - Tray measures 14"D x 14"W - Can be mounted at variable heights to the Dura-Flex upright - Universal left or right hand mount - Arm swings 180 degrees.

- 30 lb Weight Capacity
- Universal Mount
- Swings 180 Degrees
- Rubber Mat Included

Part #	Fits Frame	Description
DFXT-30	All	Universal Tool Tray with Rubber Pad

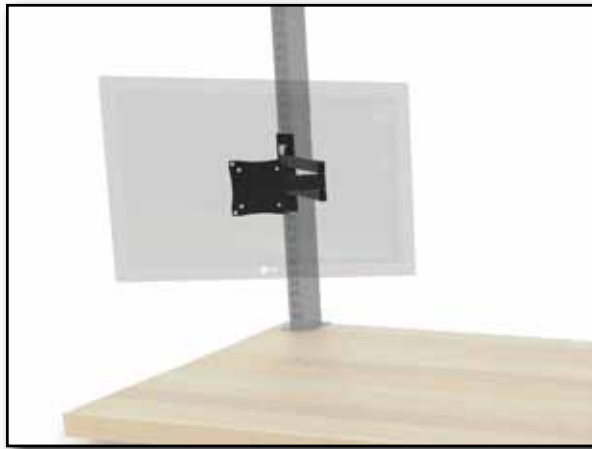

Flat Panel Monitor Arm

Adjustable mounting arm for flat panel monitors with VESA pattern mounting holes. Arm into the face of the upright. Arms keep monitors off the work surface, freeing up valuable work space.

- Fully Articulating Arm
- Steel Construction
- Mounts to Upright Face
- VESA Pattern Mounting Plate

Part #	Fits Frame	Description
DFX-MA-FP	All	Articulating Flat Panel Monitor Arm



Overhead Cabinet - Retractable Door

Overhead storage cabinet - Doors flip up and retract into the top of the cabinet - Mounts to back supports - Cylinder style locks keep contents secure - Top of cabinet will be level with top of upright.

- Flip-Up / Retractable Doors
- Welded Steel Construction
- Cylinder Style Locks
- Mounts to Upright Face

Part #	Fits Benches	Description - (2) Req. for Full Width
DFX-OHC-30	60" Wide	30"W x 15"D x 16"H - Half Width Overhead Cabinet
DFX-OHC-36	72" Wide	36"W x 15"D x 16"H - Half Width Overhead Cabinet



Worksurface Backstop

Worksurface backstops keep items from rolling off the back of the tables surface - 3" high above surface - Mounts to Dura-Flex frame - Steel construction.

- 3" High Retaining Rail
- For 60", 72", & 84" Benches
- Mounts to the Back of Uprights
- Steel Construction

Part #	Fits Benches	Description
DFX-BKS-60	60"	30"W x 3"H - Backstop - (2) Req. for Full Width
DFX-BKS-72	72"	36"W x 3"H - Backstop - (2) Req. for Full Width
DFX-BKS-84	84"	42"W x 3"H - Backstop - (2) Req. for Full Width

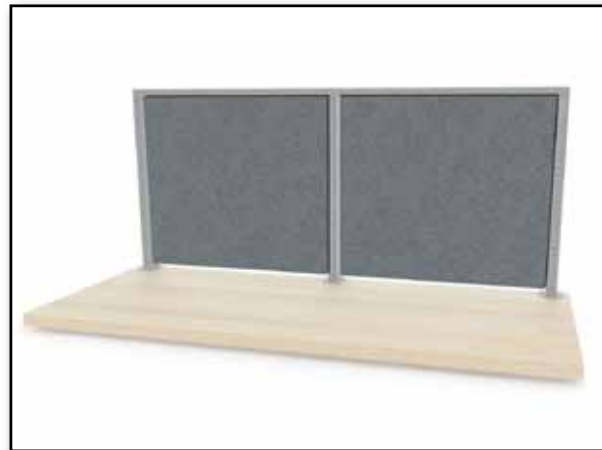

Tack Board Panel

Fabric covered homasote board allows for posting documents, prints, or work instructions above the work surface - Firmly hold tacks or push pins - Standard in gray colored fabric.

- Fabric Covered Homasote Board
- Board Hold Tacks or Push Pins
- Gray Fabric Standard
- Fabric Conceals Tack Holes

Part #	Fits Benches	Description - (2) Req. for Full Width
DFX-TKB-60-30	60" w/ 30"H Upright	30"W x 30"H Tack Board Panel
DFX-TKB-72-30	72" w/ 30"H Upright	36"W x 30"H Tack Board Panel
DFX-TKB-60-34	60" w/ 34"H Upright	30"W x 34"H Tack Board Panel
DFX-TKB-72-34	72" w/ 34"H Upright	36"W x 34"H Tack Board Panel



Dry Erase / Magnetic Whiteboard Panel

Perfect for writing out notes or posting items - Dry erase board panel mounts between uprights - For use with dry erase markers - Easy wipe clean surface - Magnetic to allow posting documents.

- Dry Erase Markers Easily Wipe Off
- Panels Mount Between Uprights
- Adds Additional Privacy
- Magnetic Surface

Part #	Fits Benches	Description - (2) Req. for Full Width
DFX-DEB-60-30	60" w/ 30"H Upright	30"W x 30"H Half Width Dry Erase Board Panel
DFX-DEB-72-30	72" w/ 30"H Upright	36"W x 30"H Half Width Dry Erase Board Panel
DFX-DEB-60-34	60" w/ 34"H Upright	30"W x 34"H Half Width Dry Erase Board Panel
DFX-DEB-72-34	72" w/ 34"H Upright	36"W x 34"H Half Width Dry Erase Board Panel



Bin Panel

Bin panels mount between Dura-Flex uprights - Panels allow for organizing a large number of items in an easy to reach position above the worksurface - Bins easily hook into panel slots.

- Bins Can Be Easily Removed
- Fits 60" and 72" Frames
- Slotted Panel for Easy Arranging
- Bins Sold Separately

Part #	Fits Benches	Description
DFX-BNP-60-30	60" w/ 30"H Upright	30"W x 30"H Slotted Bin Panel
DFX-BNP-72-30	72" w/ 30"H Upright	36"W x 30"H Slotted Bin Panel

Plastic Bins - Additional bin sizes available. Contact GMI for details.

Part #	Size	Description
DFXB-442	4.125"W x 7.375"D x 3"H	Plastic Bin

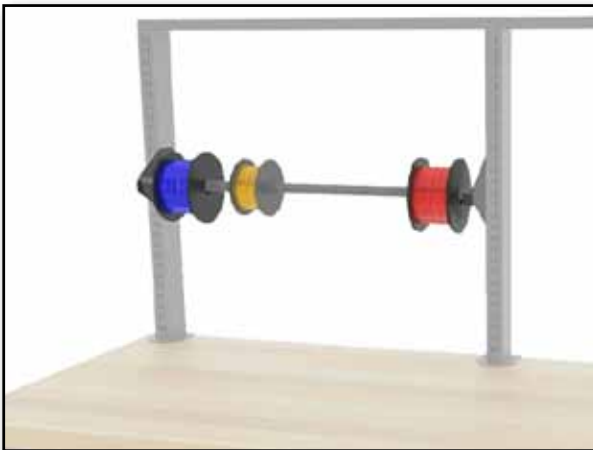

Wire Spool / Label Holder

Secure storage for wire spools, labels, tape, or packaging items on rolls - Steel rod can be removed to end load rolls - Works with spools that have a 1" diameter or larger opening in the spool - Rod brackets securely mount to the uprights.

- Removable Steel Holder Rod
- Mounts Between Uprights
- Perfect for Rolled Material
- 1" ID or Larger Spool Opening

Part #	Fits Benches	Description
DFX-WSH-60	60"	30"W Wire Spool / Label Holder
DFX-WSH-72	72"	36"W Wire Spool / Label Holder

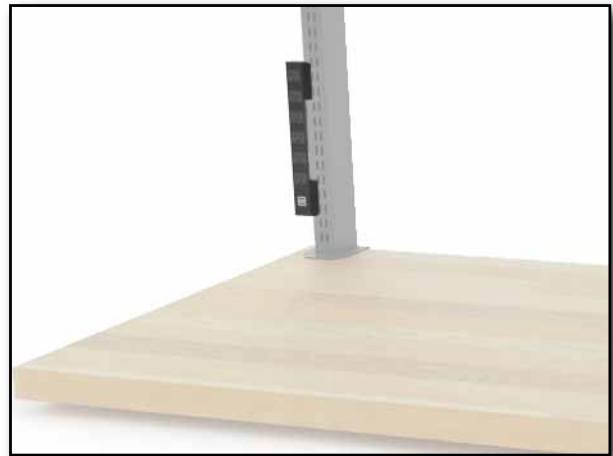

Power / USB Outlet Strip - Side Mount

Surge protected (6) 120V-15 amp outlets with a lighted on/off switch - USB ports for charging tablets, phones, or other electronic devices - Unit mounts on the side of the upright - Provided with a 6' cord & plug.

- (6) 120V-15 Amp Outlets
- USB Charging Outlets
- 6' Long Cord & Male Plug
- Positioned on Side of Upright

Part #	Fits Frame	Description
DFX-PSU-15	All	Dura-Flex Mounted - Power / Charging Strip



Double Door Shop Desk

Steel writing surface with flip up lid and storage below - Large lower storage compartment with (2) locking doors - (1) Adjustable interior shelf - 6"H tubular legs with floor anchor pads - Optional leveler foot kit available - Rear organizer shelf with (3) compartments - All welded steel construction.

Part #	Description
CB-1000	48"W x 24"D x 54"H - Double Door Shop Desk
LVL-200	3/8" x 1-1/2"H Rubber Based Leveler Foot (set of 4)



Shop Desk with Drawer Storage

Steel writing surface - (1) 16"W x 24"D cabinet containing (2) Box and (2) file drawers - (1) Personal drawer mounted under work surface - Single pedestal leg - Lower storage shelf - Rear modesty panel - Recessed plastic drawer pulls - Cylinder style drawer locks keyed alike 415A - Rear organizer shelf with (3) compartments - All welded steel construction.

Part #	Description
CB-1200	48"W x 24"D x 54"H - Shop Desk w/ Drawer Base



Double Door / Drawer Shop Desk

Steel writing surface with locking drawer storage below - Large lower storage compartment with (2) locking doors - (1) Adjustable interior shelf - 6"H legs with floor anchor pads - Optional leveler foot kit available - Rear organizer shelf with (4) compartments - All welded steel construction.

Part #	Description
ECB-1050	36"W x 28"D x 54"H - Two Door Shop Desk w/ Drawer
LVL-200	3/8" x 1-1/2"H Rubber Based Leveler Foot (set of 4)



Shop Desk with Upper Hutch

Angled steel writing surface with drawer storage below - Drawer mounted on 250lb ball bearing glides - Upper overhead storage cabinet features locking doors and one adjustable height shelf - Open base design with adjustable height foot rest shelf - Cylinder style locks - Welded Construction.

Part #	Description
ECB-13UH	32"W x 24"D x 72"H - Shop Desk w/ Upper Hutch



Open Shop Desk

Open base design with lower storage shelf - Shelf measures 14"D - Adjustable height formed channel legs constructed from 14 gauge steel - Standard with floor anchor pads - Optional leveler foot kit available - Rear leg stringer - Steel writing surface with flip up lid and storage below - Rear shelf w/ (3) compartments - Welded steel construction.

Part #	Description
CB-1300	48"W x 24"D x 54"H - Open Base Shop Desk
LVL-200	3/8" x 1-1/2"H Rubber Based Leveler Foot (set of 4)



Wall Mounted Shop Desk

Designed for secure wall mounted applications - Steel writing surface with flip up lid and storage below - Rear of body and (2) lower support braces for wall mounting - Rear organizer shelf with (3) compartments - All welded steel construction.

Part #	Description
CB-1400	48"W x 24"D x 30"H - Wall Mounted Shop Desk



Heavy Duty Door/Drawer Shop Desk

All welded 12GA steel construction - Angled steel writing surface - Welded on door hinges - Double door lower compartment w/ (1) adjustable height shelf - Secure 3 point locking door system with solid steel handle & padlock hasp - Drawer mounted on 250lb. drawer glides w/ padlock hasp - Rear organizer shelf.

Part #	Description
CBX-101DP	36"W x 28"D x 54"H - Shop Desk w/ 6"H Legs
CBX-101DP.P	36"W x 28"D x 54"H - Shop Desk w/ 5" Caster Kit



Heavy Duty Shop Desk - Multi Locker Storage

All welded 12GA steel construction - Angled steel writing surface - Welded on door hinges - Four door lower locker storage - Each door features solid steel handle & padlock hasp for secure storage of personal items - Drawer mounted on 250lb. drawer glides w/ padlock hasp - Rear organizer shelf.

Part #	Description
CBX-1D-DS4D-48	48"W x 28"D x 54"H - Shop Desk w/ (4) Locker Storage



**The EX Series:
Setting the Standard for Heavy Duty
Storage Cabinets**

Extreme Duty storage cabinets are manufactured to meet the demanding requirements of heavy use in tough environments. Constructed of 12 gauge steel exterior components featuring all welded construction. Doors are mounted on 3/8" steel pins with brass bushings, welded hinges, and allow 140 degrees of door swing. Solid steel handle accepts heavy padlock (not included). Three point latching system has a top and bottom 3/8" bar lock mechanism with a 3/16" steel plate center latch. Shelves are 14 gauge steel with formed edges. Shelves bolt into vertical supports on 2" centers. The cabinet bottom is flush with the opening. Bottom leg supports are 6" high with floor anchoring plates. Cabinets are available in any of our standard colors.

**Adjustable
Shelves with
1500 lb. Capacities**



**All Welded
Heavy Duty
Steel Hinges**



**Solid Steel
Handle with
Padlock Hasp**





	O.A.H	Cab Ht.	36"W	48"W	60"W	72"W	Shelves
24" Deep	54"	48"	EX-483-1	EX-484-1	EX-485-1	EX-486-1	3
	66"	60"	EX-603-1	EX-604-1	EX-605-1	EX-606-1	4
	84"	78"	EX-783-1	EX-784-1	EX-785-1	EX-786-1	4
	90"	84"	EX-843-1	EX-844-1	EX-845-1	EX-846-1	5
	Extra Shelf	E-SH243	E-SH244	E-SH245	E-SH246		

	O.A.H	Cab Ht.	36"W	48"W	60"W	72"W	Shelves
30" Deep	54"	48"	EX-483-30-1	EX-484-30-1	EX-485-30-1	EX-486-30-1	3
	66"	60"	EX-603-30-1	EX-604-30-1	EX-605-30-1	EX-606-30-1	4
	84"	78"	EX-783-30-1	EX-784-30-1	EX-785-30-1	EX-786-30-1	4
	90"	84"	EX-843-30-1	EX-844-30-1	EX-845-30-1	EX-846-30-1	5
	Extra Shelf	E-SH303	E-SH304	E-SH305	E-SH306		

	O.A.H	Cab Ht.	36"W	48"W	60"W	72"W	Shelves
36" Deep	54"	48"	EX-483-36-1	EX-484-36-1	EX-485-36-1	EX-486-36-1	3
	66"	60"	EX-603-36-1	EX-604-36-1	EX-605-36-1	EX-606-36-1	4
	84"	78"	EX-783-36-1	EX-784-36-1	EX-785-36-1	EX-786-36-1	4
	90"	84"	EX-843-36-1	EX-844-36-1	EX-845-36-1	EX-846-36-1	5
	Extra Shelf	E-SH363	E-SH364	E-SH365	E-SH366		

General Storage

12 gauge steel exterior components featuring all welded construction - Doors mounted on 3/8" steel pins with brass bushings, welded hinges, and allow 140 degrees of door swing - Solid steel handle accepts heavy padlock (not included) - Three point latching system with 3/8" bar lock mechanism & 3/16" steel plate center latch - 1500 lb. capacity shelves are 14 gauge steel with formed edges - Adjustable height shelves bolt into vertical supports on 2" centers - Cabinet bottom is flush with the opening - 6" high legs with floor tabs.



General Storage w/ Clear View Door

General storage cabinet with 1/4" polycarbonate panels in front doors - 14 gauge adjustable shelves - All welded door hinges - 3 point door lock with heavy duty steel padlocking handle - 6" high legs with floor tabs.

	O.A.H	Cab Ht.	36"W	48"W	60"W	72"W	Shelves
24" Deep	54"	48"	EX-483-1C	EX-484-1C	EX-485-1C	EX-486-1C	3
	66"	60"	EX-603-1C	EX-604-1C	EX-605-1C	EX-606-1C	4
	84"	78"	EX-783-1C	EX-784-1C	EX-785-1C	EX-786-1C	4
	90"	84"	EX-843-1C	EX-844-1C	EX-845-1C	EX-846-1C	5
	Extra Shelf	E-SH243	E-SH244	E-SH245	E-SH246		



Sloped Top Cabinet

General storage cabinet with 6"H slope top that reduces clutter from being stacked on top of cabinets - 14 gauge adjustable shelves - All welded door hinges - 3 point door lock with heavy duty steel padlocking handle - 6" high legs with floor tabs.

	O.A.H	Cab Ht.	36"W	48"W	60"W	72"W	Shelves
24" Deep	60"	54"	EX-483-1SL	EX-484-1SL	EX-485-1SL	EX-486-1SL	3
	72"	66"	EX-603-1SL	EX-604-1SL	EX-605-1SL	EX-606-1SL	4
	90"	84"	EX-783-1SL	EX-784-1SL	EX-785-1SL	EX-786-1SL	4
	Extra Shelf	E-SH243	E-SH244	E-SH245	E-SH246		



Fully Vented General Storage

All welded 12 gauge steel construction - General storage cabinet with vented panels on doors, back & sides - 14 gauge adjustable shelves - All welded door hinges - 3 point door lock with heavy duty steel padlocking handle - 6" high legs with floor tabs.

	O.A.H	Cab Ht.	36"W	48"W	60"W	72"W	Shelves
24" Deep	54"	48"	EX-483-1FV	EX-484-1FV	EX-485-1FV	EX-486-1FV	3
	66"	60"	EX-603-1FV	EX-604-1FV	EX-605-1FV	EX-606-1FV	4
	84"	78"	EX-783-1FV	EX-784-1FV	EX-785-1FV	EX-786-1FV	4
	90"	84"	EX-843-1FV	EX-844-1FV	EX-845-1FV	EX-846-1FV	5
	Extra Shelf		E-SH243	E-SH244	E-SH245	E-SH246	



Corner Cabinet

Solution when arranging any of our 24"D EX cabinets in the corner of two adjoining walls - Eliminates the dead space or clutter in corners - "L" Shaped shelves give better access to the back of the cabinet - 3 point door lock with steel padlocking handle - 6" high legs.

	O.A.H	Cab Ht.	Model Number	Shelves
24" D (48" OAD)	54"	48"	EX-48-CNRCAB	3
	66"	60"	EX-60-CNRCAB	4
	84"	78"	EX-78-CNRCAB	4
	90"	84"	EX-84-CNRCAB	5



Fully Vented Mobile Cabinet

Mobile storage cabinet with vented panels on doors, back & sides - 14 gauge adjustable shelves - All welded door hinges - 3 point door lock with heavy duty steel padlocking handle - 5" caster kit includes two locking/swivel and two fixed casters.

Depth	O.A.H	Cab Ht.	48"W	60"W	72"W	Shelves
24"	66.5"	60"	EX-604-1FV.P	EX-605-1FV.P	EX-606-1FV.P	3
	Extra Shelf		E-SH244	E-SH245	E-SH246	



Crew / Small Appliance Cabinet

All welded 12 gauge steel construction - (3) padlocking locker doors for multi-shift facilities offering secure storage of personal items - (2) Adjustable shelves for shared items and placement of a microwave or mini fridge - All welded door hinges - Heavy duty locks with steel padlocking handles - 6" high legs with floor tabs.

Size	Model Number	Locker Openings	Shelves
48"W x 24"D x 84"H	EX-784-1001_3	3	2



Multi-Shift Storage Cabinet

Multi-shift storage cabinet with individual 21.5"W lockable compartments for personal locker storage or multiple tool stations - (4) 14 gauge adjustable shelves per compartment - All welded door hinges - 3 point door locks with heavy duty steel padlocking handles - 6" legs w/ floor tabs

Size	Model Number	Doors	Shelves
74"W x 24"D x 84"H	EX-7874-MS3D	3	12
98"W x 24"D x 84"H	EX-7898-MS4D	4	16
122"W x 24"D x 84"H	EX-78122-MS5D	5	20



Shelf / Six Drawer Lower Storage

All welded 12 gauge steel construction - Cabinet features (6) half width 6"H lower drawers - Drawers mounted on full extension glides with a 250 lb capacity - (3) point door lock with heavy duty steel handle - All welded door hinges - (4) 14 gauge steel shelves (3 adjustable) with a weight capacity of 1500 lbs per shelf.

Size	Model Number	Drawers	Shelves
48"W x 24"D x 84"H	EX-2100-48	6	4
60"W x 24"D x 84"H	EX-2100-60	6	4



Tool & Die Cabinet

All welded 12 gauge steel construction - Cabinet features (3) angled shelves for CNC tool storage and (1) standard shelf for general storage - 3 point door lock with heavy duty steel padlocking handle - 6" high legs with floor tabs - Available with multiple tool holder sizes.

Size	Model Number	Tool Holder Sizes
36"W x 24"D x 84"H	EX-783-TDH-(add Size)	35 Taper, 40 Taper, 45 Taper, 50 Taper, HSK-63A, HSK-100A, C4, C5, C6



4 Compartment Divided Cabinet

4 compartment storage offers individual locking sections for added organization of equipment - Top sections have (3) adjustable shelves - Lower sections have (1) adjustable shelf - 3 point door locks with heavy duty steel padlocking handles - 6" high legs.

Size	Model Number	Doors	Shelves
48"W x 24"D x 84"H	EX-784-DS4DR	4	8
60"W x 24"D x 84"H	EX-785-DS4DR	4	8
72"W x 24"D x 84"H	EX-786-DS4DR	4	8



Divided Shelf / Tool Panel Cabinet

All welded 12 gauge steel construction - Cabinet features divided interior with (4) 1/2 width adjustable shelves on the left side - Steel tool panel with .375" square holes on 1.5" centers mounted to back on right hand side - All welded door hinges - 3 point door lock with heavy duty steel padlocking handle - 6" high legs with floor tabs.

Size	Model Number	Drawers	Shelves
60"W x 24"D x 84"H	EX-845-2TP	0	4
72"W x 24"D x 84"H	EX-846-2TP	0	4



Divided Storage - Full Tool Panel Back

All welded 12 gauge steel construction - All welded door hinges - Cabinet features interior full height tool panels in the rear - Panels have .375" square holes on 1.5" centers mounted to back - Dual 3 point door locks with heavy duty steel padlocking handles - 6" high legs with floor tabs.

Size	Model Number	Drawers	Shelves
60"W x 24"D x 84"H	EX-845-3TP	0	0
72"W x 24"D x 84"H	EX-846-3TP	0	0



General Storage w/ Tool Panel Doors

Tool storage cabinet with steel tool panels welded on the doors - Panels have .375" square holes on 1.5" centers - 14 gauge adjustable shelves - All welded door hinges - 3 point door lock with heavy duty steel padlocking handle - 6" high legs with floor tabs.

	O.A.H	Cab Ht.	48"W	60"W	72"W	Shelves
24" Deep	66"	60"	EX-604-TPD	EX-605-TPD	EX-606-TPD	4
	84"	78"	EX-784-TPD	EX-785-TPD	EX-786-TPD	4
	90"	84"	EX-844-TPD	EX-845-TPD	EX-846-TPD	5



Wall Mounted - Tool / Drawer Cabinet

All welded 12 gauge steel construction - Double door wall mounted cabinet with steel tool panel - Panels has .375" square holes on 1.5" centers - 4"H lower drawer mounted on 250 lb capacity glides - 3 point door lock with heavy duty steel padlocking handle.

Size	Model Number	Doors	Drawer
36"W x 14"D x 48"H	EXWM-3614-48-TP4D	2	(1) 4"H
24"W x 14"D x 48"H	EXWM-2414-48-TP4D	1	(1) 4"H



Divided Wardrobe / Storage

Cabinet features divided interior with 1/2 width hanger rod for garments on one side and 1/2 width adjustable shelves on the other - 3 point door lock with heavy duty steel padlocking handle - 6" high legs with floor tabs.

	O.A.H	Cab Ht.	36"W	48"W	60"W	72"W	Shelves
24" Deep	54"	48"	EX-483-2	EX-484-2	EX-485-2	EX-486-2	3
	66"	60"	EX-603-2	EX-604-2	EX-605-2	EX-606-2	4
	84"	78"	EX-783-2	EX-784-2	EX-785-2	EX-786-2	4
	90"	84"	EX-843-2	EX-844-2	EX-845-2	EX-846-2	5



Double Shift Wardrobe / Storage

The double shift wardrobe cabinet provides two separate locking compartments for multiple personnel storage - (2) Shelves w/ clothes hanging rod and (8) Adj. shelves - All welded door hinges - Dual 3 point door locks with heavy duty steel padlocking handles - 6" high legs with floor tabs.

Size	Model Number	Hanger Rod Shelf	Shelves
72"W x 24"D x 84"H	EX-786-2-DS	2	8



Full Width Wardrobe Cabinet

Wardrobe cabinet with single full width upper 14 gauge shelf and clothes hanging rod - All welded door hinges - 3 point door lock with heavy duty steel padlocking handle - 6" high legs with floor tabs.

	O.A.H	Cab Ht.	36"W	48"W	60"W
24" D	84"	78"	EX-783-WR	EX-784-WR	EX-785-WR
	90"	84"	EX-843-WR	EX-844-WR	EX-845-WR



Fully Vented Wardrobe Cabinet

Wardrobe cabinet with vented panels on doors, back & sides - Single full width upper 14 gauge shelf and clothes hanging rod - All welded door hinges - 3 point door lock with heavy duty steel padlocking handle - 6" high legs with floor tabs.

	O.A.H	Cab Ht.	36"W	48"W	60"W
24" D	84"	78"	EX-783-WRFV	EX-784-WRFV	EX-785-WRFV
	90"	84"	EX-843-WRFV	EX-844-WRFV	EX-845-WRFV



Personnel Storage Cabinet

The personnel storage cabinet provides multiple types of storage all in one unit - (1) Shelf w/ clothes hanging rod, (2) Adj. shelves, (1) fixed shelf, & (6) 4"H drawers mounted on ball bearing glides - All welded door hinges - 3 point door lock with heavy duty steel padlocking handle - 6" high legs with floor tabs.

	O.A.H	Cab Ht.	36"W	48"W	60"W	72"W
24"D	84"	78"	EX-783-PC1	EX-784-PC1	EX-785-PC1	EX-786-PC1
	90"	84"	EX-843-PC1	EX-844-PC1	EX-845-PC1	EX-846-PC1



Personnel Cabinet w/ Bin Storage

The personnel storage cabinet provides multiple types of storage all in one unit - (1) Shelf w/ clothes hanging rod, (2) Adj. shelves, (1) fixed shelf, & (6) 4"H drawers mounted on ball bearing glides - LH Door mounted small plastic bins measure 4.125"W x 7.375"D x 3"H- All welded door hinges - 3 point door lock with heavy duty steel padlocking handle - 6" high legs with floor tabs.

Size	Model Number	Bins (LH Door)	Drawers
48"W x 24"D x 84"H	EX-784-PC2	57	6



Personnel Cabinet w/ Tool Panel Doors

The personnel storage cabinet provides multiple types of storage all in one unit - (1) Shelf w/ clothes hanging rod, (2) Adj. shelves, (1) fixed shelf, & (6) 4"H drawers mounted on ball bearing glides - Door tool panels have .375" square holes on 1.5" centers - All welded door hinges - 3 point door lock with heavy duty steel padlocking handle - 6" high legs with floor tabs.

	O.A.H	Cab Ht.	36"W	48"W	60"W	72"W
24"D	84"	78"	EX-783-PC3	EX-784-PC3	EX-785-PC3	EX-786-PC3
	90"	84"	EX-843-PC3	EX-844-PC3	EX-845-PC3	EX-846-PC3



Mobile Janitorial Storage

Cabinet features a divided interior - 1/2 width mop/broom holder storage - (2) Wet mop head holders - (3) 1/2 width adjustable shelves on RH side - All welded door hinges - 3 point door lock with heavy duty steel padlocking handle - 5" Casters (2 swivel/locking & 2 rigid) - Partially vented lower panels - Available in solid or clearview options (clearview shown). Optional decal kits available, contact us for info.

Size	Model Number	Doors, Side & Back Panel	Shelves
54"W x 24"D x 78"H	EX-785-2-SP-JN	Solid (No Window)	3
54"W x 24"D x 78"H	EX-785-2-SP-JN-CV	Clearview Window	3



Janitorial Storage

All welded 12 gauge steel construction - Cabinet features a divided interior with 1/2 width mop and broom storage in one side and 1/2 width adjustable shelves in the other - All welded door hinges - 3 point door lock with heavy duty steel padlocking handle - 6" high legs with floor tabs - Doors available in solid or clearview options

Size	Model Number	Doors	Shelves
48"W x 24"D x 78"H	EX-784-2-JAN	Solid (No Window)	4
48"W x 24"D x 78"H	EX-784-2-JAN-C	Clearview Window	4



Double Shift Janitorial Cabinet

The double shift janitorial cabinet provides two separate locking compartments - Both sections feature a divided interior with 1/2 width mop and broom storage area and 1/2 width adjustable shelves - All welded door hinges - Dual 3 point door locks with heavy duty steel padlocking handles - 6" high legs - Two door options.

Size	Model Number	Doors	Shelves
72"W x 24"D x 84"H	EX-786-JANDS	Solid (No Window)	8
72"W x 24"D x 84"H	EX-786-JANDS-C	Clearview Window	8



Janitorial Cabinet w/ Tool Panel Doors & Drawers

Cabinet provides multiple types of storage all in one unit - Side mounted broom/mop holder, full width (2) Adj. shelves, (1) fixed shelf, & (6) 4"H drawers mounted on ball bearing glides - Door mounted tool panels have .375" square holes on 1.5" centers - All welded door hinges - 3 point door lock with heavy duty steel padlocking handle - 6" high legs with floor tabs.

Size	Model Number	Drawers	Shelves
36"W x 24"D x 84"H	EX-783-JAN-6DTPS	6	3
48"W x 24"D x 84"H	EX-784-JAN-6DTPS	6	3



Janitorial Cabinet w/ Bin & Drawer Storage

This janitorial cabinet provides multiple types of storage in one unit - LH open tall broom storage, (2) Adj. shelves, (1) fixed shelf, & (6) 4"H drawers mounted on ball bearing glides - LH Door mounted small plastic bins measure 4.125"W x 7.375"D x 3"H - All welded door hinges - 3 point door lock with heavy duty steel padlocking handle - 6" high legs with floor tabs.

Size	Model Number	Bins (LH Door)	Drawers
48"W x 24"D x 84"H	EX-784-JAN-6DBS	57	6



Bin Storage / Drawer Cabinet

All welded 12 gauge steel construction - Door mounted small plastic bins measure 4.125"W x 7.375"D x 3"H - Interior large plastic bins measure 8.25"W x 14.75"D x 7"H - Bins securely attach to mounting rails - Five drawers mounted on ball bearing glides, (2) 3"H, (2) 4"H, & (1) 6"H - (1) Adj height lower shelf - Three point door lock with heavy duty steel padlocking handle - 6" high legs with floor tabs.

Size	Model Number	Small Bins	Large Bins	Drawers
36"W x 24"D x 84"H	EX-723-1BS5D	94	16	5
48"W x 24"D x 84"H	EX-724-1BS5D	142	20	5



Bin Storage / Tool Panel Cabinet

All welded 12 gauge steel construction - Door mounted small plastic bins measure 4.125"W x 7.375"D x 3"H - Bins securely attach to mounting rail - (2) Lower shelves mounted in the bottom half of cabinet - Upper half steel tool panel with .375" square holes on 1.5" centers mounted to upper back - Three point door lock with heavy duty steel padlocking handle - 6" high legs with floor tabs.

Size	Model Number	Small Bins	Shelves
36"W x 24"D x 84"H	EX-723-1BTPS	94	2
48"W x 24"D x 84"H	EX-724-1BTPS	142	2



Divided Bin / Shelf Storage

All welded 12 gauge steel construction - Large plastic bins measure 8.25"W x 14.75"D x 7"H - Small plastic bins measure 4.125"W x 7.375"D x 3"H - Bins securely attach to mounting rails - (3) Half width adjustable shelves & (1) full width fixed upper shelf - All welded door hinges - 3 point door lock with heavy duty steel padlocking handle - 6" high legs

Size	Model Number	Small Bins	Large Bins	Shelves
48"W x 24"D x 84"H	EX-724-1DIVBS	142	21	4



Bin / Shelf Storage

All welded 12 gauge steel construction - Door mounted small plastic bins measure 4.125"W x 7.375"D x 3"H - (4) 14 gauge steel adjustable shelves - Shelves bolt into supports - Three point door lock with heavy duty steel padlocking handle - 6" high legs with floor tabs.

Size	Model Number	Small Bins	Large Bins
36"W x 24"D x 84"H	EX-723-1BS3	94	0
48"W x 24"D x 84"H	EX-724-1BS3	142	0



Bin Storage / Tool Panel

All welded 12 gauge steel construction - Door mounted small plastic bins measure 4.125"W x 7.375"D x 3"H - Bins securely attach to mounting rail - Bins are easily removable - All welded door hinges - Steel tool panel interior with .375" square holes on 1.5" centers mounted to back - Three point door lock with heavy duty steel padlocking handle - 6" high legs with floor tabs.

Size	Model Number	Small Bins	Large Bins
36"W x 24"D x 84"H	EX-723-1BTP	94	0
48"W x 24"D x 84"H	EX-724-1BTP	142	0



Bin Storage / Tool Panel

All welded 12 gauge steel construction - Large plastic bins measure 8.25"W x 14.75"D x 7"H - Small plastic bins measure 4.125"W x 7.375"D x 3"H - Bins securely attach to mounting rail - Bins are easily removable - All welded door hinges - Steel tool panel with .375" square holes on 1.5" centers mounted to upper back - Three point door lock with heavy duty steel padlocking handle - 6" high legs with floor tabs.

Size	Model Number	Small Bins	Large Bins
36"W x 24"D x 84"H	EX-723-1BS3TP	94	16
48"W x 24"D x 84"H	EX-724-1BS3TP	142	20



Bin Storage

All welded 12 gauge steel construction - Large plastic bins measure 8.25"W x 14.75"D x 7"H - Small plastic bins measure 4.125"W x 7.375"D x 3"H - Bins securely attach to mounting rail - Bins are easily removable - All welded door hinges - 3 point door lock with heavy duty steel padlocking handle - 6" high legs with floor tabs.

Size	Model Number	Small Bins	Large Bins
36"W x 24"D x 84"H	EX-723-1B	94	32
48"W x 24"D x 84"H	EX-724-1B	142	40



Bin / Shelf Storage

All welded 12 gauge steel construction - (3) adjustable shelves - Large plastic bins measure 8.25"W x 14.75"D x 7"H - Small plastic bins measure 4.125"W x 7.375"D x 3"H - Bins securely attach to mounting rail - Bins are easily removable - All welded door hinges - 3 point door lock with heavy duty steel padlocking handle - 6" high legs with floor tabs.

Size	Model Number	Small Bins	Large Bins
36"W x 24"D x 84"H	EX-723-1BS5	94	16
48"W x 24"D x 84"H	EX-724-1BS5	142	20



Wall Mounted Cabinet

All welded 12 gauge steel construction - Double door wall mounted cabinet - (2) Interior shelves - All welded door hinges - 3 point door locks with heavy duty steel padlocking handle.

Size	Model Number	Doors	Shelves
36"W x 14"D x 36"H	EXWM-3614-36	2	2
24"W x 14"D x 36"H	EXWM-2414-36	1	2



Base Cabinet

All welded 12 gauge steel construction - Double door base cabinet - (2) Interior adjustable height shelves - All welded door hinges - 3 point door locks with heavy duty steel padlocking handle.

	O.A.H	24"W	36"W	48"W	Shelves
24" Deep	30"	EX-302-BC	EX-303-BC	EX-304-BC	2
	36"	EX-362-BC	EX-363-BC	EX-364-BC	2
	42"	EX-422-BC	EX-423-BC	EX-424-BC	2



Counter Height Base Cabinet w/ Bins/Shelves

All welded 12 gauge steel construction - Double door base cabinet - (2) Interior adjustable height shelves - Door mounted small plastic bins measure 4.125"W x 7.375"D x 3"H - All welded door hinges - 3 point door locks with heavy duty steel padlocking handle.

Size	Model Number	Bins	Shelves
36"W x 24"D x 42"H	EX-423-BCBS	52	2
48"W x 24"D x 42"H	EX-424-BCBS	81	2



Counter Height Base Cabinet w/ Bins

All welded 12 gauge steel construction - Double door base cabinet - Door and interior mounted small plastic bins measure 4.125"W x 7.375"D x 3"H - All welded door hinges - 3 point door locks with heavy duty steel padlocking handle.

Size	Model Number	Door Bins	Interior Bins
36"W x 24"D x 42"H	EX-423-BCB	52	88
48"W x 24"D x 42"H	EX-424-BCB	81	99



3 Drawer / 3 Shelf Storage

All welded 12 gauge steel construction - Cabinet features 3 full width drawers mounted on full extension glides with a 250 lb capacity - (3) point door lock with heavy duty steel handle - All welded door hinges - (3) 14 gauge steel shelves (2 adjustable) with a weight capacity of 1500 lbs per shelf - 6"H legs

Size	Model Number	Drawer Heights	Shelves
36"W x 24"D x 84"H	EX-2400-36	(1) 4"H / (2) 6"H	3
48"W x 24"D x 84"H	EX-2400-48	(1) 4"H / (2) 6"H	3



5 Drawer / 3 Shelf Storage

All welded 12 gauge steel construction - Cabinet features 5 full width drawers mounted on full extension glides with a 250 lb capacity - (3) point door lock with heavy duty steel handle - All welded door hinges - (3) 14 gauge steel shelves (2 adjustable) with a weight capacity of 1500 lbs per shelf - 6"H legs

Size	Model Number	Drawer Heights	Shelves
36"W x 24"D x 84"H	EX-2500-36	(2) 3"H / (2) 4"H / (1) 6"H	3
48"W x 24"D x 84"H	EX-2500-48	(2) 3"H / (2) 4"H / (1) 6"H	3



7 Drawer / 3 Shelf Storage

All welded 12 gauge steel construction - Cabinet features 7 full width drawers mounted on full extension glides with a 250 lb capacity - (3) point door lock with heavy duty steel handle - All welded door hinges - (3) 14 gauge steel shelves (2 adjustable) with a weight capacity of 1500 lbs per shelf - 6"H legs

Size	Model Number	Drawer Heights	Shelves
36"W x 24"D x 84"H	EX-2600-36	(2) 3"H / (2) 4"H / (3) 6"H	3
48"W x 24"D x 84"H	EX-2600-48	(2) 3"H / (2) 4"H / (3) 6"H	3



10 Drawer / 3 Shelf Storage

All welded 12 gauge steel construction - Cabinet features 10 full width drawers mounted on full extension glides with a 250 lb capacity - (3) point door lock with heavy duty steel handle - All welded door hinges - (3) 14 gauge steel shelves (2 adjustable) with a weight capacity of 1500 lbs per shelf - 6"H legs

Size	Model Number	Drawer Heights	Shelves
36"W x 24"D x 84"H	EX-2700-36	(2)2"H / (3)3"H / (2)4"H / (3)6"H	3
48"W x 24"D x 84"H	EX-2700-48	(2)2"H / (3)3"H / (2)4"H / (3)6"H	3



Double Shift Storage Cabinet

All welded 12 gauge steel - General storage cabinet with two separate lockable compartments - 14 gauge adjustable shelves - All welded door hinges - Dual 3 point door locks with heavy duty steel padlocking handles - 6"H legs with floor tabs.

	O.A.H	Cab Ht.	36"W	48"W	60"W	72"W	Shelves
24" Deep	66"	60"	EX-603-DS	EX-604-DS	EX-605-DS	EX-606-DS	4
	84"	78"	EX-783-DS	EX-784-DS	EX-785-DS	EX-786-DS	4
	90"	84"	EX-843-DS	EX-844-DS	EX-845-DS	EX-846-DS	5



14 Drawer / 4 Shelf Storage

All welded 12 gauge steel construction - Cabinet features 14 half width drawers mounted on full extension glides with a 250 lb capacity - Divided cabinet has dual 3 point door locks with heavy duty steel handles - All welded door hinges - (4) 14 gauge steel shelves (2 adjustable) with a weight capacity of 1850 lbs per shelf - 6"H legs

Size	Model Number	Drawer Heights	Shelves
60"W x 24"D x 84"H	EX-4200-60	(14) 4"H	4
72"W x 24"D x 84"H	EX-4200-72	(14) 4"H	4



6 Drawer / 6 Shelf Storage

All welded 12 gauge steel construction - Cabinet features 6 half width drawers mounted on full extension glides with a 250 lb capacity - Divided cabinet has dual 3 point door locks with heavy duty steel handles - All welded door hinges - (6) 14 gauge steel shelves (4 adjustable) with a weight capacity of 1850 lbs per shelf - 6"H legs

Size	Model Number	Drawer Heights	Shelves
60"W x 24"D x 84"H	EX-4300-60	(6) 4"H	6
72"W x 24"D x 84"H	EX-4300-72	(6) 4"H	6



6 Drawer / 6 Shelf Storage

All welded 12 gauge steel construction - Cabinet features 6 half width drawers mounted on full extension glides with a 250 lb capacity - Divided cabinet has dual 3 point door locks with heavy duty steel handles - All welded door hinges - (6) 14 gauge steel shelves (4 adjustable) with a weight capacity of 1850 lbs per shelf - 6"H legs

Size	Model Number	Drawer Heights	Shelves
60"W x 24"D x 84"H	EX-4400-60	(2) 4"H / (4) 6"H	6
72"W x 24"D x 84"H	EX-4400-72	(2) 4"H / (4) 6"H	6



Variable 10 Drawer / 6 Shelf Storage

All welded 12 gauge steel construction - Cabinet features 10 half width drawers mounted on full extension glides with a 250 lb capacity - Divided cabinet has dual 3 point door locks with heavy duty steel handles - All welded door hinges - (6) 14 gauge steel shelves (4 adjustable) with a weight capacity of 1850 lbs per shelf - 6"H legs

Size	Model Number	Drawer Heights	Shelves
60"W x 24"D x 84"H	EX-4500-60	(4) 3"H / (4) 4"H / (2) 6"H	6
72"W x 24"D x 84"H	EX-4500-72	(4) 3"H / (4) 4"H / (2) 6"H	6



Variable 14 Drawer / 6 Shelf Storage

All welded 12 gauge steel construction - Cabinet features 14 half width drawers mounted on full extension glides with a 250 lb capacity - Divided cabinet has dual 3 point door locks with heavy duty steel handles - All welded door hinges - (6) 14 gauge steel shelves (4 adjustable) with a weight capacity of 1850 lbs per shelf - 6"H legs

Size	Model Number	Drawer Heights	Shelves
60"W x 24"D x 84"H	EX-4600-60	(4) 3"H / (4) 4"H / (6) 6"H	6
72"W x 24"D x 84"H	EX-4600-72	(4) 3"H / (4) 4"H / (6) 6"H	6



Variable 20 Drawer / 6 Shelf Storage

All welded 12 gauge steel construction - Cabinet features 20 half width drawers mounted on full extension glides with a 250 lb capacity - Divided cabinet has dual 3 point door locks with heavy duty steel handles - All welded door hinges - (6) 14 gauge steel shelves (4 adjustable) with a weight capacity of 1850 lbs per shelf - 6"H legs

Size	Model Number	Drawer Heights	Shelves
60"W x 24"D x 84"H	EX-4700-60	(4)2"H / (6)3"H / (4)4"H / (6)6"H	6
72"W x 24"D x 84"H	EX-4700-72	(4)2"H / (6)3"H / (4)4"H / (6)6"H	6



Variable 28 Drawer / 2 Shelf Storage

All welded 12 gauge steel construction - Cabinet features 28 half width drawers mounted on full extension glides with a 250 lb capacity - Divided cabinet has dual 3 point door locks with heavy duty steel handles - All welded door hinges - (2) 14 gauge steel fixed height shelves with a weight capacity of 1850 lbs per shelf - 6"H legs

Size	Model Number	Drawer Heights	Shelves
60"W x 24"D x 84"H	EX-4800-60	(14)3"H / (6)4"H / (8)6"H	2
72"W x 24"D x 84"H	EX-4800-72	(14)3"H / (6)4"H / (8)6"H	2



Wardrobe / Shelf Locker Cabinets

Storage cabinet with individual 21.5"W x 36.75"H lockable compartments for personal locker storage - Each compartment features wardrobe section w/ (2) coat hooks - (2) 14 gauge adjustable shelves - All welded door hinges - 3 point door locks with heavy duty steel padlocking handles - 6" legs w/ floor tabs

Size	Model Number	Doors	Shelves
26"W x 24"D x 84"H	EXL-2624-WS2D	2	4
50"W x 24"D x 84"H	EXL-5024-WS4D	4	8
74"W x 24"D x 84"H	EXL-7424-WS6D	6	12
98"W x 24"D x 84"H	EXL-9824-WS8D	8	16



Drawer / Shelf Locker Cabinets

Storage cabinet with individual 21.5"W x 36.75"H lockable compartments for personal locker storage - Each compartment features (2) 4"H drawers on ball bearing glides - 14 gauge shelves - All welded door hinges - 3 point door locks with heavy duty steel padlocking handles - 6" legs w/ floor tabs

Size	Model Number	Doors	Drawers
26"W x 24"D x 84"H	EXL-2624-DS2D	2	4
50"W x 24"D x 84"H	EXL-5024-DS4D	4	8
74"W x 24"D x 84"H	EXL-7424-DS6D	6	12
98"W x 24"D x 84"H	EXL-9824-DS8D	8	16



Single-Tier Storage Locker w/ Shelves

Single-tier locker cabinet with shelf storage - All welded 12 gauge steel - 14 Gauge shelves - Welded on door hinges - 3 Point door lock with heavy duty steel padlocking handle - 6"H legs - Available w/ flat top or 6"H angled slope top.

Size	Model Number	Shelves	Top Style
18"W x 18"D x 66"H	EXL-1818-66S	4	Flat Top
18"W x 18"D x 72"H	EXL-1818-72S-SL	4	Slope Top



4-Tier Locker / General Storage Cabinet

Combination unit provides individual lockers w/ a general use storage cabinet - (8) 14.75"W x 18"H locker compartments - 31.75"W x 74"H general storage area w/ (4) adj. 14GA shelves - Welded on door hinges - Heavy steel padlocking handles - 6"H legs.

Size	Model Number	Shelves	Lockers
70"W x 24"D x 84"H	EXL-7024-4TGS	4	8



Single-Tier Narrow Lockers

Heavy 12 gauge steel lockers that will last a lifetime in any school or industrial environment - Each locker opening is 10"W x 18"D - Features a wardrobe hanging rod & shelf in each section - All welded door hinges - 3 point door locks w/ heavy steel padlocking handles

Size	Model Number	Doors
14"W x 18"D x 84"H	EXL-1418-NST1D	1
38"W x 18"D x 84"H	EXL-3818-NST3D	3
50"W x 18"D x 84"H	EXL-5018-NST4D	4
74"W x 18"D x 84"H	EXL-7418-NST6D	6

• Sloped Top Option - Add "-SL" to part number. Note: Adds 6" to OAH.



Double-Tier Narrow Lockers

Heavy 12 gauge steel lockers that will last a lifetime in any school or industrial environment - Each 1/2 height opening is 10"W x 18"D - Features (2) interior hooks for hanging items - All welded door hinges - 3 point door locks w/ heavy duty steel padlocking handles

Size	Model Number	Doors
14"W x 18"D x 84"H	EXL-1418-NDT2D	2
38"W x 18"D x 84"H	EXL-3818-NDT6D	6
50"W x 18"D x 84"H	EXL-5018-NDT8D	8
74"W x 18"D x 84"H	EXL-7418-NDT12D	12

• Sloped Top Option - Add "-SL" to part number. Note: Adds 6" to OAH.



3-Tier Locker Cabinet

Three-tier locker cabinet - All welded 12 gauge steel - 14.75"W x 24.50"H individual locker compartments - Welded on door hinges - Secure door lock with heavy duty steel padlocking handle - 6"H legs

Size	Model Number	Doors
53"W x 24"D x 84"H	EXL-5324-3T9D	9
70"W x 24"D x 84"H	EXL-7024-3T12D	12



4-Tier Locker Cabinet

Four-tier locker cabinet - All welded 12 gauge steel - 14.75"W x 18"H individual locker compartments - Welded on door hinges - Secure door lock with heavy duty steel padlocking handle - 6"H legs

Size	Model Number	Doors
53"W x 24"D x 84"H	EXL-5324-4T12D	12
70"W x 24"D x 84"H	EXL-7024-4T16D	16



Jobsite Storage Unit

All welded 12 gauge steel unit provides secure storage for locations where outside storage is required - Rear of unit features (3) 12"D full width adjustable height shelves - 24"D open front section allows for storing of larger bulk items - Internal hinges - Gas shocks for easy lifting and closing - Lid locks with heavy duty 3 point lock and locking handle - Fork pocket base

Size	Model Number	Doors	Shelves
60"W x 36"D x 48"H	EXJ-6036-JSB1	1	3



Jobsite Storage Unit w/ Front Ramp

All welded 12 gauge steel unit provides secure storage for locations where outside storage is required - Rear of unit features (3) 12"D full width adjustable height shelves - 24"D front section w/ drop down loading ramp allows for storing of larger bulk items - Internal hinges - Gas shocks for easy lifting & closing - Heavy duty 3 point lock and locking handle - Fork pocket base

Size	Model Number	Doors	Shelves
60"W x 36"D x 48"H	EXJ-6036-JSB2	1	3



Jobsite Cabinet - General Storage

All welded 12GA steel unit provides secure storage for locations where outside storage is required - Divided interior has (4) 14GA half width adjustable height shelves - All welded door hinges - Side push/pull handle - (4) welded top lifting lugs - Unit mounted on large 6" casters (2 fixed / 2 swivel/locking) allow for easier moving on uneven surfaces - Fork pockets included for forklift transport - Heavy duty recessed locking handle.

Size	Model Number	Shelves	Doors
48"W x 24"D x 67.50"H	EXJ-4824-JSC1	4	2
60"W x 24"D x 67.50"H	EXJ-6024-JSC1	4	2



Jobsite Cabinet - Drawer / Tool Panel

Welded 12GA steel unit provides secure outside storage - (8) Variable height drawers mounted on 250lb drawer glides - Steel peg board interior in top 3/4 of LH compartment - (3) 14GA half width shelves - (3) Door mounted steel pockets - All welded door hinges - Side push/pull handle - (4) welded top lifting lugs - Unit mounted on large 6" casters (2 fixed / 2 swivel/locking) allow for easier moving on uneven surfaces - Fork pockets - Heavy duty recessed locking handle.

Size	Model Number	Shelves	Drawer Heights
48"W x 24"D x 67.50"H	EXJ-4824-JSC2	3	(2) 2" / (2) 4" / (2) 3" / (2) 6"
60"W x 24"D x 67.50"H	EXJ-6024-JSC2	3	(2) 2" / (2) 4" / (2) 3" / (2) 6"

EX Series - Flammable Storage

All welded extreme duty storage cabinet. Double wall steel exterior (12GA shell with 16GA interior panels) with 1.625" insulating air gap between panels. Upper and lower side vents. 2" deep bottom catch pan helps to contain spills inside the cabinet. Three adjustable height galvanized shelves. Manual closing double doors with welded on hinges. Cabinet contents are secured with a 3 point door lock and a heavy duty steel padlocking handle. 6"H enclosed base.



Part #	Description
EXFLM-4418-43	30 Gallon Capacity - 44"W x 18"D x 43"H
EXFLM-5818-60	60 Gallon Capacity - 58"W x 18"D x 60"H



Flammable Cabinet

Store your flammable liquids safely. These flammable safety cabinets comply with the National Fire Protection Association Flammable Combustible Liquid Code #30 and OSHA standard 1910.106 for flammable storage of 1, 2 and 3 liquids. FM approved. Double walled 18-gauge all-welded steel with 1-1/2" insulating air space. Safety storage cabinet includes a built in grounding connector, dual 2" vents, and has a 2"d leak proof doorsill. The 350 lb capacity galvanized steel shelves adjust on 3" centers. Doors have full length piano hinges. Cabinet features a recessed paddle handle with cylinder lock and padlocking latch for security. Stainless steel 3-point self-latching system provides positive door locking. Adjustable leveling feet for uneven floors. Durable powder coat finish with warning labels.

Part #	Description
WCF-3672FL-M	(45 Gallon) 18"D x 43"W x 65"H Cabinet with Manual Doors
WCF-3672FL-S	(45 Gallon) 18"D x 43"W x 65"H Cabinet with Self Closing Doors

Pesticide Cabinet

Pesticide Storage cabinet safely stores insecticides, herbicides, and other turf chemicals. Pesticide Safety cabinet complies with National Fire Protection Association specifications, OSHA regulations, and is approved by the Factory Mutual System. Double walled 18-gauge all-welded steel with 1-1/2" insulating air space. Storage cabinet includes a built-in grounding connector, dual 2" vents, and has a 2"D leak proof doorsill. The 350 lb capacity galvanized steel shelves adjust on 3" centers. Doors have full length piano hinges. Cabinet features a recessed paddle handle with cylinder lock and padlocking latch for security. Stainless steel 3-point self-latching system provides positive door locking. Adjustable leveling feet for uneven floors. Durable powder coat finish with warning labels.



Part #	Description
WCP-3672P30-M	(30 Gallon) 18"D x 43"W x 44"H Cabinet with Manual Doors
WCP-3672P45-M	(45 Gallon) 18"D x 43"W x 65"H Cabinet with Manual Doors
WCP-3672P60-M	(60 Gallon) 31.25"D x 31.25"W x 65"H Cabinet with Manual Doors



Adjustable Shelves with 1450 lb. Capacities



Solid Steel Handle with Padlock Hasp



All Welded Heavy Duty Steel Hinges

**Medium Duty Series:
Durable Cabinets in a Welded
14 Gauge Construction.**

Medium Duty storage cabinets are built using the same quality standards as our Extreme Duty line, but in a medium duty construction. Constructed with all welded 14 gauge steel components, these cabinets will stand the test of time. Doors are mounted on 3/8" steel pins with brass bushings, welded hinges, and allow 140 degrees of door swing. Solid steel handle accepts heavy padlock (not included). Three point latching system has a top and bottom 3/8" bar lock mechanism with a 3/16" steel plate center latch. Shelves are 14 gauge steel with formed edges. Shelves bolt into vertical supports on 2" centers. The cabinet bottom is flush with the opening. Bottom leg supports are 4" high with floor anchoring plates.





General Storage

All welded 14 gauge steel construction - (4) 14 gauge steel adjustable shelves - Shelves bolt into supports - Flush bottom pan - All welded door hinges - 3 point door lock with heavy duty steel padlocking handle - 4" high legs with floor tabs.

	O.A.H	Cab Ht.	36"W	42"W	48"W	60"W
24" Deep	78"	74"	MDC-3624-78	MDC-4224-78	MDC-4824-78	MDC-6024-78
	82"	78"	MDC-3624-82	MDC-4224-82	MDC-4824-82	MDC-6024-82



Divided Wardrobe Storage

All welded 14 gauge steel construction - Cabinet features divided interior with 1/2 width hanger rod for garments on one side and (4) 1/2 width adjustable shelves on the other - 3 point door lock with heavy duty steel padlocking handle - 4" high legs with floor tabs.

	O.A.H	Cab Ht.	36"W	48"W	60"W
24" Deep	78"	74"	MDC-3624-78-WD	MDC-4824-78-WD	MDC-6024-78-WD
	82"	78"	MDC-3624-82-WD	MDC-4824-82-WD	MDC-6024-82-WD



Wire Spool Cabinet

All welded 14 gauge steel construction - (3) Adjustable wire spool racks for holding & dispensing bulk wire - (3) 14 gauge steel adjustable shelves - All welded door hinges - 3 point door lock with heavy duty steel padlocking handle - 4" high legs with floor tabs.

Size	Model Number	Spool Racks	Shelves
36"W x 24"D x 82"H	MDC-3624-82-WIRE	3	3



4 Drawer Storage

All welded 14 gauge steel construction - (4) 100 Series drawers - (3) 14 gauge steel shelves (2 adjustable / 1 fixed) - All welded door hinges - 3 point door lock with heavy duty steel padlocking handle - 4" high legs with floor tabs.

Size	Model Number	Usable Drawer Height	Shelves
36"W x 24"D x 82"H	MDC-3624-82-DRW01	(4) 3"H	3
48"W x 24"D x 82"H	MDC-4824-82-DRW01	(4) 3"H	3



4 Drawer Storage

All welded 14 gauge steel construction - (1) 100, (2) 150, & (1) 200 Series Drawers - (3) 14 gauge steel shelves (2 adjustable / 1 fixed) - All welded door hinges - 3 point door lock with heavy duty steel padlocking handle - 4" high legs with floor tabs.

Size	Model Number	Usable Drawer Height	Shelves
36"W x 24"D x 82"H	MDC-3624-82-DRW02	(1) 3" / (2) 5" / (1) 7"	3
48"W x 24"D x 82"H	MDC-4824-82-DRW02	(1) 3" / (2) 5" / (1) 7"	3



5 Drawer Storage

All welded 14 gauge steel construction - (1) 100, (2) 150, (1) 200, (1) 250 Series drawers - (3) 14 gauge steel shelves (2 adjustable / 1 fixed) - All welded door hinges - 3 point door lock with heavy duty steel padlocking handle - 4" high legs with floor tabs.

Size	Model Number	Usable Drawer Height	Shelves
36"W x 24"D x 82"H	MDC-3624-82-DRW03	(1)3" / (2)5" / (1)7" / (1)9.25"	3
48"W x 24"D x 82"H	MDC-4824-82-DRW03	(1)3" / (2)5" / (1)7" / (1)9.25"	3



4 Drawer Storage

All welded 14 gauge steel construction - (4) 150 Series Drawers - (3) 14 gauge steel shelves (2 adjustable / 1 fixed) - All welded door hinges - 3 point door lock with heavy duty steel padlocking handle - 4" high legs with floor tabs.

Size	Model Number	Usable Drawer Height	Shelves
36" w x 24" d x 82" h	MDC-3624-82-DRW04	(4) 5"	3
48" w x 24" d x 82" h	MDC-4824-82-DRW04	(4) 5"	3



6 Drawer Storage

All welded 14 gauge steel construction - (2)100, (2)150, (2)200 Series drawers - (3) 14 gauge steel shelves (2 adjustable / 1 fixed) - All welded door hinges - 3 point door lock with heavy duty steel padlocking handle - 4" high legs with floor tabs.

Size	Model Number	Usable Drawer Height	Shelves
36"W x 24"D x 82"H	MDC-3624-82-DRW05	(2) 3" / (2) 5" / (2) 7"	3
48"W x 24"D x 82"H	MDC-4824-82-DRW05	(2) 3" / (2) 5" / (2) 7"	3



Interior Drawer/Door Combination

All welded 16 gauge steel construction - (4) drawers with 200 lb bearing glides - Drawers mounted inside of full height doors - Upper section of doors have panel mounting rails - **Optional** 3/4" birch (blank) or 1/4" pegboard interior tool panels.

Size	Model Number	Description
48"W x 24"D x 84"H	GTV-4200	Tool Cabinet - No Panels
48"W x 24"D x 84"H	GTV-4200B	Tool Cabinet - Blank 3/4" Birch Panels
48"W x 24"D x 84"H	GTV-4200P	Tool Cabinet - Blank 1/4" Peg Board Panels



Tool Panel/Bin Combination

All welded 16 gauge steel construction - (2) doors with heavy duty three point lock - Upper section with panel mounting rails - (56) 4 1/8"W x 7 3/8"D x 3"H bins on doors - (6) 13.75"W x 19"D x 4.375"H totes - 4"h legs - **Optional** 3/4" birch (blank) or 1/4" pegboard tool panel.

Size	Model Number	Description
48"W x 24"D x 84"H	GTV-4000	Tool Cabinet - No Panels
48"W x 24"D x 84"H	GTV-4000B	Tool Cabinet - Blank 3/4" Birch Panels
48"W x 24"D x 84"H	GTV-4000P	Tool Cabinet - Blank 1/4" Peg Board Panels



Variable Drawer/Door Tool Vault

All welded 16 & 14 ga steel construction - IHL 900 series bottom cabinet features 7 variable height drawers - (2)2", (2)3", (2)5", & (1) 9.2" high drawers - IHL 750 series double door upper section for larger tools or peg board options for additional organization - Doors feature three point lock - **Optional** 3/4" birch (blank) or 1/4" pegboard interior tool panels.

Size	Model Number	Description
48"W x 24"D x 75"H	IHLTV-6000	Tool Cabinet - No Panels
48"W x 24"D x 75"H	IHLTV-6000B	Tool Cabinet - Blank 3/4" Birch Panels
48"W x 24"D x 75"H	IHLTV-6000P	Tool Cabinet - Blank 1/4" Peg Board Panels



Optional Peg Board Panels Shown

External Drawer/Door Combination

All welded 16 gauge steel construction - (6) drawers with 200 lb bearing glides - Upper double door cabinet with panel mounting rails - **Optional** 3/4" birch (blank) or 1/4" pegboard interior tool panels.

Size	Model Number	Description
48"W x 24"D x 84"H	GTV-4400	Tool Cabinet - No Panels
48"W x 24"D x 84"H	GTV-4400B	Tool Cabinet - Blank 3/4" Birch Panels
48"W x 24"D x 84"H	GTV-4400P	Tool Cabinet - Blank 1/4" Peg Board Panels

The WC-Series is our premium duty tall storage cabinet that looks great in any classroom or industrial setting. Built with quality and longevity in mind, these storage cabinets feature a full 2" face frame and all welded 16 gauge steel construction. Doors are equipped with recessed aluminum handles and a three point lock for security. Doors mounted on heavy duty concealed hinges with a 105 degree door swing. Cabinet bases have a 4" h recessed riser and include heavy duty leveler feet with rubber pads. Cabinets are available in a variety of sizes and interior configurations. Our cabinets will provide years of use in commercial environments.



Cabinet doors feature heavy duty overlay hinges with detents in the closed position.



Cabinet interiors have full length adjustable shelf supports. Shelves are rated to 400 lbs. and adjustable in 1" increments.



All welded face frame with corners ground smooth. A recessed 4" h recessed riser with leveler feet is standard.





Vented Door Option



Available with vented door front option. Add "V" to part number listed in the part # chart below.
(Sample Pt #) WC3-3642V



General Storage

Wardrobe Cabinet

Double Door Storage Cabinet - All welded 16 gauge steel construction - (4) Adjustable shelves - Recessed aluminum handles - Three point locking mechanism with cylinder lock keyed alike - Recessed 4" h kick riser - Floor levelers - Standard with solid doors - Available in Clear View and Vented door options.

Double Door Wardrobe Cabinet - All welded 16 gauge steel construction - (4) 1/2 width adjustable shelves - 1/2 width clothes hanger rod - Three point locking mechanism with cylinder lock keyed alike - Recessed 4" h kick riser - Floor levelers - Standard with solid doors - Available in Clear View and Vented door options.

O.A.H	Cab Ht.	24"W	36"W	48"W	60"W	Shelf #	Std. Depth
42"	38"	WC3-2442	WC3-3642	WC3-4842	WC3-6042	3	24"
60"	56"	WC3-2460	WC3-3660	WC3-4860	WC3-6060	4	24"
72"	68"	WC3-2472	WC3-3672	WC3-4872	WC3-6072	4	24"
84"	80"	WC3-2484	WC3-3684	WC3-4884	WC3-6084	4	24"
Extra Shelf		WC-24S	WC-36S	WC-48S	WC-60S		

O.A.H	Cab Ht.	24"W	36"W	48"W	60"W	Shelf #	Std. Depth
42"	38"	WC4-2442	WC4-3642	WC4-4842	WC4-6042	3	24"
60"	56"	WC4-2460	WC4-3660	WC4-4860	WC4-6060	4	24"
72"	68"	WC4-2472	WC4-3672	WC4-4872	WC4-6072	4	24"
84"	80"	WC4-2484	WC4-3684	WC4-4884	WC4-6084	4	24"
Extra Shelf		WC-24S5	WC-36S5	WC-48S5	WC-60S5		



Clear View Door Option



Available with Clear View door front option. Add "C" to part number listed in the part # chart below.
(Sample Pt #) WC3-3642C



Wardrobe Storage Fixed Upper Shelf

Wardrobe Storage Fixed Lower Shelf

Double Door Wardrobe Cabinet - All welded 16 gauge steel construction - (1) fixed full width upper shelf - (3) 1/2 width adjustable shelves - 1/2 width clothes hanger rod - Recessed aluminum handles - Three point locking mechanism with cylinder lock keyed alike - Recessed 4" h kick riser - Floor levelers - Standard with solid doors - Available in Clear View and Vented door options.

Double Door Wardrobe Cabinet - All welded 16 gauge steel construction - (1) fixed full width lower shelf - 1/2 width adjustable shelves - (3) 1/2 width clothes hanger rod - Recessed aluminum handles - Three point locking mechanism with cylinder lock keyed alike - Recessed 4" h kick riser - Floor levelers - Standard with solid doors - Available in Clear View and Vented door options.

O.A.H	Cab Ht.	24"W	36"W	48"W	60"W	Shelf #	Std. Depth
60"	56"	WC5-2460	WC5-3660	WC5-4860	WC5-6060	4	24"
72"	68"	WC5-2472	WC5-3672	WC5-4872	WC5-6072	4	24"
84"	80"	WC5-2484	WC5-3684	WC5-4884	WC5-6084	4	24"
Extra Shelf		WC-24S5	WC-36S5	WC-48S5	WC-60S5		

O.A.H	Cab Ht.	24"W	36"W	48"W	60"W	Shelf #	Std. Depth
60"	56"	WC6-2460	WC6-3660	WC6-4860	WC6-6060	4	24"
72"	68"	WC6-2472	WC6-3672	WC6-4872	WC6-6072	4	24"
84"	80"	WC6-2484	WC6-3684	WC6-4884	WC6-6084	4	24"
Extra Shelf		WC-24S5	WC-36S5	WC-48S5	WC-60S5		



Vented Door Option



Available with vented door front option. Add "V" to part number listed in the part # chart below.
(Sample Pt #) WC3-3642V

Mobile General Storage

Mobile Double Door Storage Cabinet - All welded 16 gauge steel construction - Adjustable shelves - Recessed aluminum handles - Three point locking mechanism with cylinder lock keyed alike - Heavy duty 5" caster kit (2 fixed / 2 swivel/locking) - Standard with solid doors - Available in Clear View and Vented door options.

O.A.H	Cab Ht.	24"W	36"W	48"W	60"W	Shelf #	Std. Depth
44.5"	38"	WC3-2444.P	WC3-3644.P	WC3-4844.P	WC3-6044.P	3	24"
62.5"	56"	WC3-2462.P	WC3-3662.P	WC3-4862.P	WC3-6062.P	4	24"
74.5"	68"	WC3-2474.P	WC3-3674.P	WC3-4874.P	WC3-6074.P	4	24"
Extra Shelf		WC-24S	WC-36S	WC-48S	WC-60S		



Janitorial Storage

Double Door Janitorial Storage Cabinet - Welded 16ga steel construction - Adj. shelves on LH side - Open broom storage on RH side - Recessed aluminum handles - Three point locking mechanism with cylinder lock - Recessed 4"H kick riser - Floor levelers - Standard with solid doors - Available in Clear View and Vented door options.

O.A.H	Cab Ht.	36"W	48"W	60"W	Shelf #	Std. Depth
60"	56"	WC-JAN-3660	WC-JAN-4860	WC-JAN-6060	4	24"
72"	68"	WC-JAN-3672	WC-JAN-4872	WC-JAN-6072	4	24"
84"	80"	WC-JAN-3684	WC-JAN-4884	WC-JAN-6084	4	24"
Extra Shelf		WC-36S5	WC-48S5	WC-60S5		



Clear View Door Option



Available with Clear View door front option. Add "C" to part number listed in the part # chart below.
(Sample Pt #) WC3-3642C

Full Width Wardrobe Cabinet

Double Door Full Width Wardrobe Cabinet - All welded 16 gauge steel construction - Full width clothes hanger rod - Three point locking mechanism with cylinder lock - Recessed 4"H kick riser - Floor levelers - Standard with solid doors - Available in Clear View and Vented door options.

O.A.H	Cab Ht.	24"W	36"W	48"W	60"W	Std. Depth
60"	56"	WC9-2460	WC9-3660	WC9-4860	WC9-6060	24"
72"	68"	WC9-2472	WC9-3672	WC9-4872	WC9-6072	24"
84"	80"	WC9-2484	WC9-3684	WC9-4884	WC9-6084	24"



Lounge / Break Area Cabinet

Double Door Cabinet - All welded 16 gauge steel construction - Split interior with (2) LH 1/2 width adjustable shelves, wide enough for a small microwave - RH open interior for mini fridge storage - Vented rear with cord cutout on RH side - Padlock hasp - Standard with vented doors - Available with flat or sloped top.

Size	Model Number	Cabinet Top Style	Shelves
48"W x 24"D x 48"H	WC3-4848.SP2	Flat	2
48"W x 24"D x 54"H	WC3-4848.SP3	Sloped	2

EX Series Computer Enclosures:

The EX Series computer enclosures are built using all welded 12 gauge steel and designed to provide heavy duty protection for valuable computer terminals on the shop floor.



EXC-2672FDS.P



Table Top Enclosure

Overall size - 26"W x 24"D x 37"H - All welded 12 gauge steel construction. Doors mounted on heavy duty welded hinges. Built in cooling fan. Pull out keyboard tray / drawer. Comes with 7 outlet power strip. Padlocking.

Part #	Description
EXC-2637DT	Desktop Computer Cabinet - Pull Out Keyboard Tray/Drawer



Cabinet w/ Pull Out Keyboard Drawer

Overall size - 26"W x 24"D x 72"H - Welded 12GA steel. Heavy duty welded door hinges. Built in cooling fan. 3 Point padlocking system on lower cabinet w/ (2) adj. shelves. Pull out keyboard tray w/ padlock hasp. 7 Outlet power strip.

Part #	Description
EXC-2672FDS EXC-2672FDS.P	Cabinet w/ Lower Storage Mobile w/ 6" Caster Kit - Pull Handle - Floor Lock



Cabinet w/ Front Shelf

Overall size - 26"W x 36"D x 72"H - Welded 12GA steel. Heavy duty welded door hinges. Built in cooling fan. 3 Point padlocking system on lower cabinet w/ (2) adj. shelves. Front keyboard shelf. 7 Outlet power strip.

Part #	Description
EXC-2672FS EXC-2672FS.P	Cabinet w/ Front Shelf Mobile w/ 6" Casters - Floor Lock



Cabinet w/ Front & Side Shelf(s)

Overall size - 36"D x 72"H - Welded 12GA steel. Heavy duty welded door hinges. Built in cooling fan. 3 Point padlocking system on lower cabinet w/ (2) adj. shelves. Front keyboard shelf. Side shelf(s). 7 Outlet power strip.

Part #	Description
EXC-4372WD EXC-6772WD	Cabinet w/ RH Shelf - 43"W Cabinet w/ LH & RH Shelf - 67"W



Flat Panel Cabinet w/ Drawer & Shelf

Overall size - 26"W x 24"D x 66"H - Welded 12GA steel. Heavy duty welded door hinges. Built in cooling fan. 3 Point padlocking system on lower cabinet w/ pull out shelf. Pull out keyboard tray / drawer. 7 outlet power strip.

Part #	Description
EXC-2666F	Flat Panel Monitor Cabinet - Pull Out Lower Shelf / Keyboard Tray

DT Series Computer Enclosures:

Dura-Tech computer enclosures are designed to provide security and protection for computer terminals on the shop floor. The units are made of 16 and 18 gauge steel all welded construction. Upper cabinet features an adjustable shelf and is large enough to accept most video monitors. Cooling fan pulls filtered air from outside creating positive pressure inside the cabinet to help eliminate contamination of sensitive equipment.

Features:

- Polycarbonate window in door for monitor viewing.
- Adjustable monitor shelf.
- 120V, 15amp (4) outlet strip in lower cabinet.
- Optional 5" caster base.
- Pull out keyboard/mouse drawer.
- Cylinder style drawer/door locks keyed alike.
- Filtered cooling fan in lower cabinet.
- Power cord pass through in rear of cabinet.
- Available in three height options.



Part #	Description
MGDTC-1000	30"W x 29"D x 48"H - Computer Enclosure
MGDTC-1100	30"W x 29"D x 57"H - Computer Enclosure
MGDTC-1200	30"W x 29"D x 64"H - Computer Enclosure
MGDTC-RB	Optional 5" Riser Base with Fork Lift Pockets - Replaces Casters



Pull out keyboard/mouse drawer features a sliding tray for additional storage.

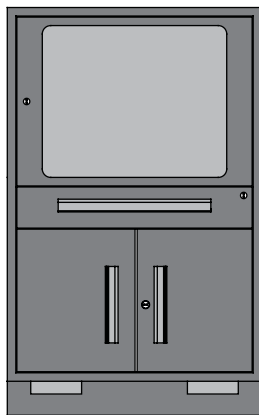

MGDTC-1000

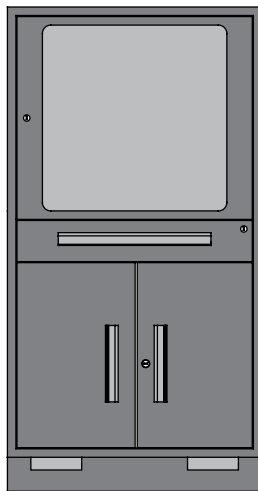

MGDTC-1100

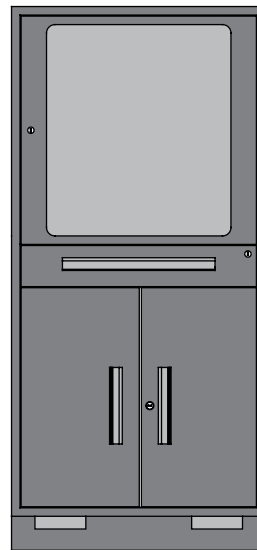

MGDTC-1200

Shown with optional 5" riser base.



Lower cabinet features a filtered cooling fan and (4) outlet 120V, 15 amp plug strip.



Plastic Tote Tray

Tote measures 13.75"W x 19"D x 4.375"H
- Heavy gauge polyethylene material - Available in tan only.

Part #	Description
TOTE-1319	Single Tote Tray



Power Aprons

Universal power aprons - Aprons can be used with Dura-Flex or mount directly to work surface - Provides 120V-15 amp outlets with a lighted on/off switch - Provided with cord & plug.

Part #	Description
DTPA-24	24" Power Apron
DTPA-48	48" Power Apron
DTPA-72	72" Power Apron



LED Interior Cabinet Light

Adds interior light to tool cabinets - 120v x 15 amp circuit required - Optional on/off switch or automatic magnetic switch.

Part #	Description
ICL-M	Interior Light Kit - Manual Switch
ICL-A	Interior Light Kit - Auto Switch

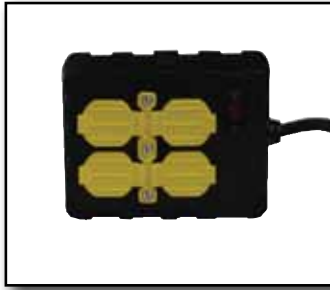

Power Outlet Box

Box has a lighted circuit breaker switch that indicates power is on - (4) 120V x 15 amp outlets with covers - Constructed of sturdy plastic - 6' heavy-duty 12 gauge power cord.

Part #	Description
DTPWR-4	Four Outlet Box with Cord



Electronic Keypad Locks

Keypad lock provides a keyless locking option. Easy to clean membrane keypad. Allows 19 user codes & 1 supervisor code. Batteries last for 75,000 cycles. Low battery indicator. Must order with cabinets.

Part #	Description
ELOC-KP	Electronic Keypad Lock



Polyethylene Plastic Bins

Two standard sizes - Small bins measure 4.125"W x 7.375"D x 3"H - Large bins measure 8.25"W x 14.75"D x 7"H - Available in yellow only - Special sizes available upon request.

Part #	Description
GBN-4-Y	4.125"W x 7.375"D x 3"H - Small Bin
GBN-8-Y	8.25"W x 14.75"D x 7"H - Large Bin

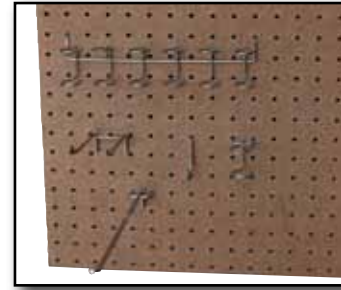

Standard Peg Board Tool Hook Kit

200 piece assorted tool hook kit that includes:
50 - small "J" hooks 50 - medium "J" hooks
25 - 4" straight hooks 25 - 2" straight hooks
20 - single loop hooks 20 - angled hooks
05 - loop racks 05 - hook racks

Part #	Description
PEG-200	200 Piece Hook Kit



Bluetooth Electronic Lock

Bluetooth padlocks put control in the palm of your hand. Unlock your lock, share access with guests, and monitor activity - all with one easy-to-use app. Locks come in outdoor and indoor models.

Part #	Description
ELOC-BTPL-ID	Indoor Bluetooth Padlock
ELOC-BTPL-OD	Outdoor Bluetooth Padlock

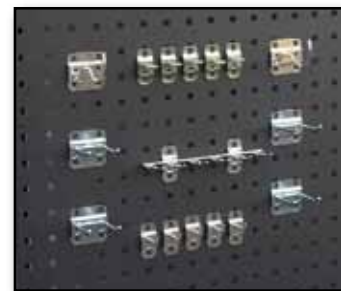

Square Hole Panel Tool Hooks

63 piece assorted tool hook kit that includes:
05 - 1" rod hook 05 - medium spring clip
05 - 3" rod hook 05 - spring clip/can
05 - 6" rod hook 05 - small spring clip
05 - 1-1/4" circle 05 - 2" curved hook
05 - 3" double hook (30) 05 - hammer/plier holder
05 - 3" double hook (90) 03 - multi prong toll holder
05 - 3" double hook (80)

Part #	Description
SQPEG-400	63 Piece Square Hook Kit

Our modular shelving system handles the storage of large bulk items, small parts, tooling, and supplies all in one unit. Available in multiple drawer and shelf configurations to fit most applications. Racks are offered in standard 18" or 24" deep units. The optional storage drawers for the 36" w and 48" w models are equipped with a formed steel handle. Drawers are standard with 200 lb. capacity glides and are available with glide capacities up to 400 lbs. Drawers accept optional divider kits. Racks are configured as starters and add-on units.



Features:

- Shelf units available in heights from 60"H to 96"H.
- Standard depths of 18" and 24".
- Formed 13 gauge all welded channel frames.
- Floor anchor holes.
- Strong reinforced 16 gauge steel shelves.
- Shelves adjust on 1-1/2" centers.
- Optional galvanized steel shelves. Contact GMI.
- Standard rack frame color is Charcoal Gray.
- Multiple drawer configurations.
- Optional side and back panels.



Heavy Duty Drawer Glides:

All drawers are mounted on 200 lb. capacity full extension drawer glides.



Heavy Duty Shelf Supports:

Shelves adjust on 1-1/2" centers and support loads up to 400 lbs.



Drawer Divider Kits:

GRC-Modular Drawers are available with optional drawer divider kits.

Starter

Add-On



Shown with Optional Side and Back Panels





Starter

Add-On

Open / Basic Racks:

- Open Base Rack
- (2) Fixed Shelves
- (4) Adjustable Shelves
- Rear Anti Sway Braces
- Order as Starter or Add On Modules
- Add Optional Side Panels
- Add Optional Back Panels

	Height	18" Deep		24" Deep	
		Starter	Add-on	Starter	Add-On
36" w	72	GRC-1836-72.S	GRC-1836-72.A	GRC-2436-72.S	GRC-2436-72.A
	84	GRC-1836-84.S	GRC-1836-84.A	GRC-2436-84.S	GRC-2436-84.A
	96	GRC-1836-96.S	GRC-1836-96.A	GRC-2436-96.S	GRC-2436-96.A
48" w	72	GRC-1848-72.S	GRC-1848-72.A	GRC-2448-72.S	GRC-2448-72.A
	84	GRC-1848-84.S	GRC-1848-84.A	GRC-2448-84.S	GRC-2448-84.A
	96	GRC-1848-96.S	GRC-1848-96.A	GRC-2448-96.S	GRC-2448-96.A



Interior Panel

End Panel

Add-On Side and Interior Divider Panels:

- Constructed of 16 Gauge Steel
- Use End Panels for Exterior Sides
- Panels Sold Separately
- Panels Attach Easily
- Adds Security
- Optional Tool End Panels

Rack Height	18" Deep Panels		24" Deep Panels	
	End Side Panel	Interior Side Panel	End Side Panel	Interior Side Panel
72	GSP-1884-ED__	GSP-1884-IN	GSP-2484-ED__	GSP-2484-IN
84	GSP-1884-ED__	GSP-1884-IN	GSP-2484-ED__	GSP-2484-IN
96	GSP-1896-ED__	GSP-1896-IN	GSP-2496-ED__	GSP-2496-IN

Add "TP" to Part Number For Tool Panel Option

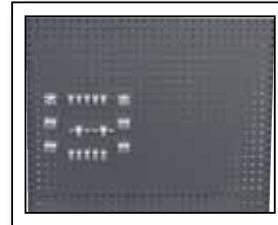

Optional Tool Panel

Tool End Panel Option

Tool panel option allows the organization of tools and equipment at the ends of the rack sections. End panels ordered with the tool panel option have .375 square holes on 1.5" centers and accommodate most tool holders designed for square holes on 1.5" centers. Available for all size GRC Rack configurations.



Back Panels

Add-On Back Panels:

- Constructed of 16 Gauge Steel
- Panels Bolt to Rear of Frame
- Back Panels Sold Separately
- Panel Replaces Rear Braces
- Increase Security

Rack Height	36" Wide Panels	48" Wide Panels
72	GBP-3672	GBP-4872
84	GBP-3684	GBP-4884
96	GBP-3696	GBP-4896



Series 360/480

(4) 4" Drawers - (4) Shelves - Pre-configured starter units are provided with (2) end and (1) back panel - Add-on units are provided with (1) interior panel and (1) back panel - For optional drawer divider kits see page 115 - All units are 84"H.

Width	18" Deep		24" Deep	
	Starter	Add-on	Starter	Add-On
36"	GRC-360-18S	GRC-360-18A	GRC-360-24S	GRC-360-24A
48"	GRC-480-18S	GRC-480-18A	GRC-480-24S	GRC-480-24A



Series 361/481

(2) 4" and (2) 6" Drawers - (4) Shelves - Pre-configured starter units are provided with (2) end and (1) back panel - Add-on units are provided with (1) interior panel and (1) back panel - For optional divider kits see page 115 - All units are 84"H.

Width	18" Deep		24" Deep	
	Starter	Add-on	Starter	Add-On
36"	GRC-361-18S	GRC-361-18A	GRC-361-24S	GRC-361-24A
48"	GRC-481-18S	GRC-481-18A	GRC-481-24S	GRC-481-24A



Series 362/482

(3) 4" and (1) 10" Drawers - (4) Shelves - Pre-configured starter units are provided with (2) end and (1) back panel - Add-on units are provided with (1) interior panel and (1) back panel - For optional divider kits see page 115 - All units are 84"H.

Width	18" Deep		24" Deep	
	Starter	Add-on	Starter	Add-On
36"	GRC-362-18S	GRC-362-18A	GRC-362-24S	GRC-362-24A
48"	GRC-482-18S	GRC-482-18A	GRC-482-24S	GRC-482-24A



Series 363/483

(1) 4", (2) 6" and (1) 10" Drawers - (4) Shelves - Pre-configured starter units are provided with (2) end and (1) back panels - Add-on units are provided with (1) interior panel and (1) back panel - For optional divider kits see page 115 - All units are 84"H.

Width	18" Deep		24" Deep	
	Starter	Add-on	Starter	Add-On
36"	GRC-363-18S	GRC-363-18A	GRC-363-24S	GRC-363-24A
48"	GRC-483-18S	GRC-483-18A	GRC-483-24S	GRC-483-24A

Pre-configured racks are supplied with standard 200 lb capacity drawer glides. Add .HD to the part number for 400 lb capacity drawer glide option.



Shown with Optional Divider Kit

Features:

- All drawers feature full extension glides.
- Standard 200 lb capacity glides.
- Up to 400 lb glides available.
- 16 gauge steel drawer box.
- Integrated handle with label holder.
- All welded construction.

Individual GRC-Series Drawers

- For 36" w and 48" w Racks
- 18" d and 24" d Depths
- Order Drawer Divider Kits Separately
- Standard 200 Lb Capacity Glides
- Up to 400 Lb Capacity Available
- Includes Blank Label

	Drawer Face Height	Inside Height	18" Deep	24" Deep
36" w	3"	2"	D36-183	D36-243
	4"	3"	D36-184	D36-244
	6"	5"	D36-186	D36-246
	7"	6"	D36-187	D36-247
	9"	8"	D36-189	D36-249
	10"	9"	D36-1810	D36-2410
	12"	11"	D36-1812	D36-2412
48" w	3"	2"	D48-183	D48-243
	4"	3"	D48-184	D48-244
	6"	5"	D48-186	D48-246
	7"	6"	D48-187	D48-247
	9"	8"	D48-189	D48-249
	10"	9"	D48-1810	D48-2410
	12"	11"	D48-1812	D48-2412
	13"	12"	D48-1813	D48-2413

Add .HD to the part number for 400 lb capacity drawer glide option.
Add .CL to the part number for cylinder type drawer lock.

GRC-Drawer Divider Kits

Drawer divider kits will assist in keeping your small parts organized and readily available. Choose from pre-configured kits or individual components to make your own drawer configuration. Slotted partitions adjust on 3/4" centers and run the full depth of the drawer.

- For 36"W and 48"W Drawers
- 18"D and 24"D Depths
- Order One Kit per Drawer
- Dividers are Moveable
- Tab for Labeling
- Special Configurations Available

Standard Configurations

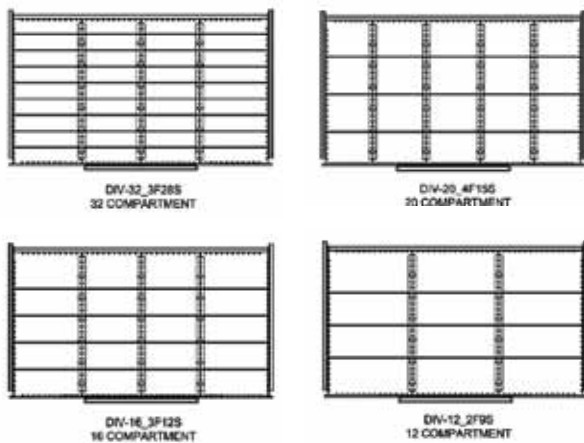

	Drawer Height	Divider Compartments	18" Deep	24" Deep
36" W Shelf Unit	3"	32	DIV-32_3F28S-GRC-3618-3	DIV-32_3F28S-GRC-3624-3
	3"	20	DIV-20_4F15S-GRC-3618-3	DIV-20_4F15S-GRC-3624-3
	3"	16	DIV-16_3F12S-GRC-3618-3	DIV-16_3F12S-GRC-3624-3
	3"	12	DIV-12_2F9S-GRC-3618-3	DIV-12_2F9S-GRC-3624-3
	4"	32	DIV-32_3F28S-GRC-3618-4	DIV-32_3F28S-GRC-3624-4
	4"	20	DIV-20_4F15S-GRC-3618-4	DIV-20_4F15S-GRC-3624-4
	4"	16	DIV-16_3F12S-GRC-3618-4	DIV-16_3F12S-GRC-3624-4
	4"	12	DIV-12_2F9S-GRC-3618-4	DIV-12_2F9S-GRC-3624-4
	6" and Up	32	DIV-32_3F28S-GRC-3618-6	DIV-32_3F28S-GRC-3624-6
	6" and Up	20	DIV-20_4F15S-GRC-3618-6	DIV-20_4F15S-GRC-3624-6
48" W Shelf Unit	6" and Up	16	DIV-16_3F12S-GRC-3618-6	DIV-16_3F12S-GRC-3624-6
	6" and Up	12	DIV-12_2F9S-GRC-3618-6	DIV-12_2F9S-GRC-3624-6
	3"	32	DIV-32_3F28S-GRC-4818-3	DIV-32_3F28S-GRC-4824-3
	3"	20	DIV-20_4F15S-GRC-4818-3	DIV-20_4F15S-GRC-4824-3
	3"	16	DIV-16_3F12S-GRC-4818-3	DIV-16_3F12S-GRC-4824-3
	3"	12	DIV-12_2F9S-GRC-4818-3	DIV-12_2F9S-GRC-4824-3
	4"	32	DIV-32_3F28S-GRC-4818-4	DIV-32_3F28S-GRC-4824-4
	4"	20	DIV-20_4F15S-GRC-4818-4	DIV-20_4F15S-GRC-4824-4
	4"	16	DIV-16_3F12S-GRC-4818-4	DIV-16_3F12S-GRC-4824-4
	4"	12	DIV-12_2F9S-GRC-4818-4	DIV-12_2F9S-GRC-4824-4
	6" and Up	32	DIV-32_3F28S-GRC-4818-6	DIV-32_3F28S-GRC-4824-6
	6" and Up	20	DIV-20_4F15S-GRC-4818-6	DIV-20_4F15S-GRC-4824-6
	6" and Up	16	DIV-16_3F12S-GRC-4818-6	DIV-16_3F12S-GRC-4824-6
	6" and Up	12	DIV-12_2F9S-GRC-4818-6	DIV-12_2F9S-GRC-4824-6

GR Series Racks

Our GR-Series of open shelving is ideal for storage of packaged material and other bulk items. Open design allows for high visibility and easy access to stored items. Shelving units are constructed from formed 13 gauge steel uprights and are standard with 16 gauge steel reinforced shelves. Shelves are adjustable on 1-1/2" centers and feature a full front and rear support brace. Shelves have a 400 lb capacity each. Uprights are equipped with front to rear braces for added stability. Rear anti sway braces keep racks solidly in place. Anchor pads for floor mounting are standard. GMI offers stainless steel and galvanized steel shelves for special applications. Please contact us for details.

Features:

- Shelf units available in heights from 60"H to 96"H.
- Standard depths of 12" to 30".
- Formed 13 gauge steel uprights.
- Floor anchor pads.
- Strong reinforced 16 gauge steel shelves.
- Shelves adjust on 1-1/2" centers.
- Optional galvanized or stainless steel shelves. Contact GMI.



Shelf Clip Pocket



Reinforced Shelves

GR Series Open Racks

	Height	12" Deep	18" Deep	24" Deep	30" Deep	# of Shelves (Steel)
24" Wide	60	GR-1224-60	GR-1824-60	GR-2424-60	GR-3024-60	4
	72	GR-1224-72	GR-1824-72	GR-2424-72	GR-3024-72	4
	84	GR-1224-84	GR-1824-84	GR-2424-84	GR-3024-84	5
	96	GR-1224-96	GR-1824-96	GR-2424-96	GR-3024-96	5
30" Wide	60	GR-1230-60	GR-1830-60	GR-2430-60	GR-3030-60	4
	72	GR-1230-72	GR-1830-72	GR-2430-72	GR-3030-72	4
	84	GR-1230-84	GR-1830-84	GR-2430-84	GR-3030-84	5
	96	GR-1230-96	GR-1830-96	GR-2430-96	GR-3030-96	5
36" Wide	60	GR-1236-60	GR-1836-60	GR-2436-60	GR-3036-60	4
	72	GR-1236-72	GR-1836-72	GR-2436-72	GR-3036-72	4
	84	GR-1236-84	GR-1836-84	GR-2436-84	GR-3036-84	5
	96	GR-1236-96	GR-1836-96	GR-2436-96	GR-3036-96	5
48" Wide	60	GR-1248-60	GR-1848-60	GR-2448-60	GR-3048-60	4
	72	GR-1248-72	GR-1848-72	GR-2448-72	GR-3048-72	4
	84	GR-1248-84	GR-1848-84	GR-2448-84	GR-3048-84	5
	96	GR-1248-96	GR-1848-96	GR-2448-96	GR-3048-96	5



Bin Rack

These bin racks offer a great solution for storing larger bulk items that require easy access. Shelving units are constructed from formed 13 gauge steel uprights and are standard with 16 gauge steel reinforced shelves. 400 lb capacity per shelf. Floor anchor pads. Heavy duty polyethylene bins are available in red, blue, and gray. Ships standard with gray unless otherwise specified.

Features:

- Shelf units available in two standard widths.
- Formed 13 gauge steel uprights.
- Floor anchor pads.
- Strong 16 gauge steel shelves.
- Shelves adjust on 1-1/2" centers.
- Standard rack frame color is Charcoal Gray.

Complete Bin Racks

Model Number	Description	Size	Number of Bins	Bin Size
GR-1836-75BN	Bin Shelving	36"W x 18"D x 75"H	15	17.5"L x 10.875"W x 12.5"H
GR-3042-75BN	Bin Shelving	42"W x 30"D x 75"H	10	28"L x 18"W x 12"H

Replacement Bins

Model Number	Description	Size
18200BN-RD	Red Plastic Bin	17.5"L x 10.875"W x 12.5"H
18200BN-BL	Blue Plastic Bin	17.5"L x 10.875"W x 12.5"H
18200BN-GR	Gray Plastic Bin	17.5"L x 10.875"W x 12.5"H
19200BN-RD	Red Plastic Bin	28"L x 18"W x 12"H
19200BN-BL	Blue Plastic Bin	28"L x 18"W x 12"H
19200BN-GR	Gray Plastic Bin	28"L x 18"W x 12"H



GRT-Tire Rack

Rack units are constructed from formed 13 gauge steel uprights and are standard with 12 gauge steel shelves. Rack will accommodate most standard automotive tires and rims. Available as a stationary or portable rack. 400 lb capacity per shelf. Floor anchor pads are standard on stationary rack.

Features:

- All welded construction of 12 gauge steel.
- Two shelf rack measures 18"D x 60"W x 66"H.
- Three shelf rack measures 18"D x 60"W x 84"H.
- Mobile rack available in two shelf configuration only.
- 5" heavy duty casters on mobile rack.
- Adjustable shelf positions.

Model Number	Description
GRT-2460-2	Two Shelf Tire Rack
GRT-2460-2.M	Mobile Two Shelf Tire Rack
GRT-2460-3	Three Shelf Tire Rack



GRT-2460-2.M Shown

EL-Series - 200/277/279 Vertical Racks

Features:

- Constructed of heavy 16 GA steel with 11 GA formed angle supports.
- Standard racks are 48" wide.
- Two sizes of rear sheet storage compartments for both wood & metal.
- Vertical storage compartments hold up to 10' lengths of stock.
- Bottom retaining rail keeps stock from shifting out of compartments.
- Horizontal shelves measure 12", 18", and 24" deep.
- Shelf capacity is 300lbs*. * Weight evenly distributed.
- Available in Structural Gray Only.

Model Number	Vertical Storage Compartments	Sheet Storage	Overall Size
EL-277	3 @ 16"W	N/A	48"W x 30"D x 95.25"H
EL-200	3 @ 16"W - 1 Divided	24"D	48"W x 54.5"D x 99"H
EL-279	5 @ 9.625"W	8"D	48"W x 48"D x 99"H

Units are Recommended to be Floor Anchored



EL-277



EL-200 - 24"D Rear Sheet Storage



EL-279 - 8"D Rear Sheet Storage

EL-Series - 1900 Small Vertical Rack

Features:

- Constructed of 11 gauge formed angle steel.
- Overall size: 36"W x 24"D x 84"H.
- Bottom retaining rail keeps stock from shifting out of compartments.
- Three 14 gauge horizontal shelves for holding short material.
- Shelves have a 300 lb. capacity.
- Available in Structural Gray Only.

Model Number
EL-1900

Units are Recommended to be Floor Anchored



Plywood/Sheet End Loading Rack

Features:

- Overall size 72”L x 54-1/2”W x 72”H
- 1-1/4” tubular steel uprights.
- (6) All welded shelf frame assemblies.
- Designed for plywoods and other flat materials.
- End loading.
- Rated for 500lbs per shelf - Weight evenly distributed.
- Floor anchor pads.
- **Ships with open deck frames - Decking material not included.**

Model Number
EL-644

Units are Recommended to be Floor Anchored

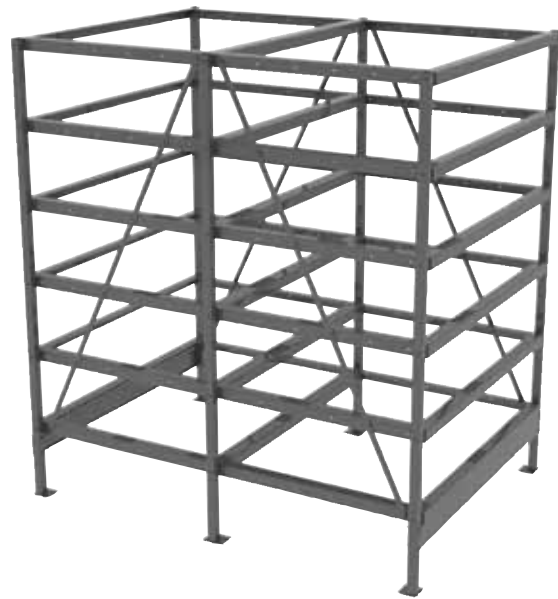

Plywood/Sheet Side Loading Rack

Features:

- Overall size 102”L x 52”W x 72”H
- Formed 11 gauge steel upright supports.
- 11 gauge steel U channel support braces.
- (6) All welded shelf frame assemblies.
- Designed for plywoods and other flat materials.
- Side loading.
- Rated for 700lbs per shelf - Weight evenly distributed.
- Floor anchor pads.
- **Ships with open deck frames - Decking material not included.**

Model Number
EL-664

Units are Recommended to be Floor Anchored



General Lumber Rack

Features:

- Overall size 144”L x 41”W x 94”H
- 1-1/4” tubular steel upright supports.
- (4) 144” x 11 gauge anti-sway braces.
- (4) 20” and (1) 38” deep shelves.
- Designed for straight lumber.
- Rated for 400lbs per shelf - Weight evenly distributed.

Model Number
EL-2

Units are Recommended to be Wall Anchored

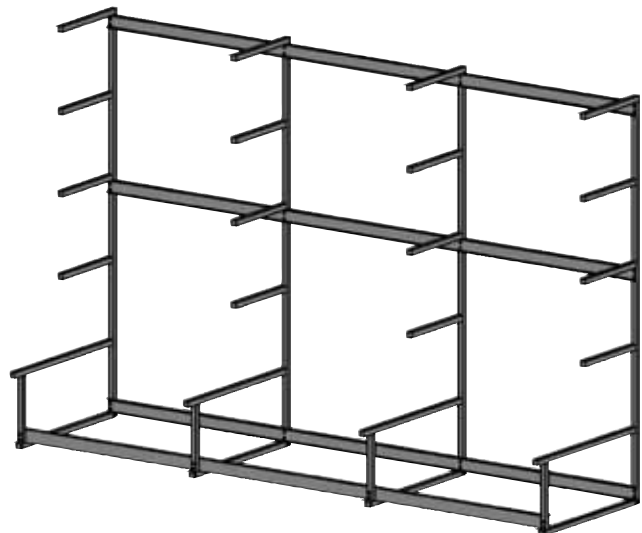

GSR/GWR Wall Mounted Steel/Wood Racks

Features:

- Uprights are constructed of heavy 3" steel channel with 7 gauge steel shelves.
- Overall size per upright unit is 3"W x 84"H.
- Shelving uprights may be purchased individually or as an assembly.
- Steel rack includes (4) uprights with (7) 12"D shelves and a 13-1/2"D floor pad.
- Wood rack includes (4) uprights with (7) 18"D shelves and a 20"D floor pad.
- Maximum capacity per shelf assembly is 1000 lbs.
- Available in Structural Gray.

Model Number	Description
GSR-4	Steel Rack Assembly - 1" Lip up on Shelf Arms
GWR-4	Wood Rack Assembly - Flat Arms
GSR-4-S	Steel Single Upright - 1" Lip up on Shelf Arms
GWR-4-S	Wood Single Upright - Flat Arms

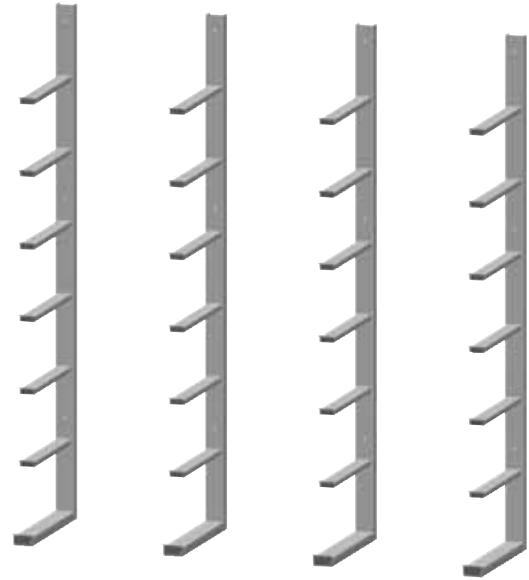

Bar Clamp Storage Rack

Features:

- Overall size 73"W x 28"D x 66"H
- Constructed of 11 and 14 gauge steel.
- Accommodates bar clamps of various sizes.
- 8"W tray along back for storage of tools.
- Optional 3" swivel locking casters.
- Available in Structural Gray.

Model Number	Description
ELR-100	Clamp Rack
ELR-100.C	Mobile Clamp Rack



Glue and Clamp Rack

Features:

- Overall size 40"W x 72"D x 68"H
- Constructed of 11 and 14 gauge steel.
- Accommodates clamping on both sides.
- Optional 3" swivel locking casters.
- Available in Structural Gray.

Model Number	Description
ELR-200	Glue and Clamp Rack / No Casters
ELR-200C	Glue and Clamp Rack / With Casters



GMBR - Bulk Storage Racks

Heavy duty bulk storage racks feature formed 11 gauge steel uprights that are punched to allow for 1-1/2" adjustment of shelf beams. The 14 gauge steel shelf beams are supplied with two tie bars per level. Racks are configured as starters and add-ons and require one starter unit per row. Racks are available with optional wood or steel panel decking material. Decking material sold separately.



Starter



Add-On

Decking Material Type	
WD	3/4" Thick Plywood
MTL	12 Gauge Steel - 11.875"W x Rack Depth Panels

	Depth	Type	60" Wide	72" Wide	84" Wide	96" Wide	Shelves
60" High	24"	Starter	GMBR-2460-60S	GMBR-2472-60S	GMBR-2484-60S	GMBR-2496-60S	3
		Add-On	GMBR-2460-60A	GMBR-2472-60A	GMBR-2484-60A	GMBR-2496-60A	
	30"	Starter	GMBR-3060-60S	GMBR-3072-60S	GMBR-3084-60S	GMBR-3096-60S	3
		Add-On	GMBR-3060-60A	GMBR-3072-60A	GMBR-3084-60A	GMBR-3096-60A	
	36"	Starter	GMBR-3660-60S	GMBR-3672-60S	GMBR-3684-60S	GMBR-3696-60S	3
		Add-On	GMBR-3660-60A	GMBR-3672-60A	GMBR-3684-60A	GMBR-3696-60A	
	48"	Starter	GMBR-4860-60S	GMBR-4872-60S	GMBR-4884-60S	GMBR-4896-60S	3
		Add-On	GMBR-4860-60A	GMBR-4872-60A	GMBR-4884-60A	GMBR-4896-60A	
72" High	24"	Starter	GMBR-2460-72S	GMBR-2472-72S	GMBR-2484-72S	GMBR-2496-72S	3
		Add-On	GMBR-2460-72A	GMBR-2472-72A	GMBR-2484-72A	GMBR-2496-72A	
	30"	Starter	GMBR-3060-72S	GMBR-3072-72S	GMBR-3084-72S	GMBR-3096-72S	3
		Add-On	GMBR-3060-72A	GMBR-3072-72A	GMBR-3084-72A	GMBR-3096-72A	
	36"	Starter	GMBR-3660-72S	GMBR-3672-72S	GMBR-3684-72S	GMBR-3696-72S	3
		Add-On	GMBR-3660-72A	GMBR-3672-72A	GMBR-3684-72A	GMBR-3696-72A	
	48"	Starter	GMBR-4860-72S	GMBR-4872-72S	GMBR-4884-72S	GMBR-4896-72S	3
		Add-On	GMBR-4860-72A	GMBR-4872-72A	GMBR-4884-72A	GMBR-4896-72A	
84" High	24"	Starter	GMBR-2460-84S	GMBR-2472-84S	GMBR-2484-84S	GMBR-2496-84S	4
		Add-On	GMBR-2460-84A	GMBR-2472-84A	GMBR-2484-84A	GMBR-2496-84A	
	30"	Starter	GMBR-3060-84S	GMBR-3072-84S	GMBR-3084-84S	GMBR-3096-84S	4
		Add-On	GMBR-3060-84A	GMBR-3072-84A	GMBR-3084-84A	GMBR-3096-84A	
	36"	Starter	GMBR-3660-84S	GMBR-3672-84S	GMBR-3684-84S	GMBR-3696-84S	4
		Add-On	GMBR-3660-84A	GMBR-3672-84A	GMBR-3684-84A	GMBR-3696-84A	
	48"	Starter	GMBR-4860-84S	GMBR-4872-84S	GMBR-4884-84S	GMBR-4896-84S	4
		Add-On	GMBR-4860-84A	GMBR-4872-84A	GMBR-4884-84A	GMBR-4896-84A	
96" High	24"	Starter	GMBR-2460-96S	GMBR-2472-96S	GMBR-2484-96S	GMBR-2496-96S	4
		Add-On	GMBR-2460-96A	GMBR-2472-96A	GMBR-2484-96A	GMBR-2496-96A	
	30"	Starter	GMBR-3060-96S	GMBR-3072-96S	GMBR-3084-96S	GMBR-3096-96S	4
		Add-On	GMBR-3060-96A	GMBR-3072-96A	GMBR-3084-96A	GMBR-3096-96A	
	36"	Starter	GMBR-3660-96S	GMBR-3672-96S	GMBR-3684-96S	GMBR-3696-96S	4
		Add-On	GMBR-3660-96A	GMBR-3672-96A	GMBR-3684-96A	GMBR-3696-96A	
	48"	Starter	GMBR-4860-96S	GMBR-4872-96S	GMBR-4884-96S	GMBR-4896-96S	4
		Add-On	GMBR-4860-96A	GMBR-4872-96A	GMBR-4884-96A	GMBR-4896-96A	
Metal Decking	24"		DK-2460-MTL	DK-2472-MTL	DK-2484-MTL	DK-2496-MTL	1
	30"		DK-3060-MTL	DK-3072-MTL	DK-3084-MTL	DK-3096-MTL	
	36"		DK-3660-MTL	DK-3672-MTL	DK-3684-MTL	DK-3696-MTL	
	48"		DK-4860-MTL	DK-4872-MTL	DK-4884-MTL	DK-4896-MTL	
Wood Decking	24"		DK-2460-WD	DK-2472-WD	DK-2484-WD	DK-2496-WD	1
	30"		DK-3060-WD	DK-3072-WD	DK-3084-WD	DK-3096-WD	
	36"		DK-3660-WD	DK-3672-WD	DK-3684-WD	DK-3696-WD	
	48"		DK-4860-WD	DK-4872-WD	DK-4884-WD	DK-4896-WD	



Wood Decking



Metal Decking



Shelf Detail

GMPR - Pallet Storage Racks

The GMPR pallet racks offer quick and easy, tool free assembly for all your pallet storage needs. These pre-configured starter and add-on industrial storage rack systems are made of durable heavy gauge steel. Heavy duty, one-piece 13 gauge steel uprights allow height adjustments at 2" increments for easy pallet rack beam adjustment. High strength 15 gauge steel beams have a 1-5/8"H step beam design that accommodates cross bars and decking. Beams provide secure connection to upright frame using a positive locking action; right to left, front to back and up and down. Lock automatically snaps into place and secures beam. Welded braces provide maximum rigidity and stability. 12 gauge welded base plate anchors upright to floor and distributes weight evenly. Uprights feature a long lasting epoxy finish. Starter unit includes 2 upright frames and 2 pairs of shelf beams. Add-On units include 1 upright frame and 2 pairs of shelf beams. Capacity based on 36" beam level spacing.



Heavy Duty Cross Shelf Beams:

High strength 15 gauge steel beams have a 1-5/8"H step beam design that accommodates cross bars and decking.



Features:

- 13 Gauge Steel Uprights.
- 15 Gauge Steel Cross Beams
- Beams Adjust on 2" Increments.
- Beams Positive Lock into Uprights.
- 12 Gauge Welded Base Plate Anchors.
- Racks Sold in Starter & Add-On Units.



Shelf Beam Locks:

Lock automatically snaps into place and secures beam.

	Width	Depth	Starter Unit	Add-On Unit	Weight Capacity (lbs)	Beam Height
96" High	48"	36"	GMPR-4836-96S	GMPR-4836-96A	6590	3-5/16"
	96"	36"	GMPR-9636-96S	GMPR-9636-96A	7160	5-1/8"
	108"	36"	GMPR-10836-96S	GMPR-10836-96A	6420	5-1/8"
	120"	36"	GMPR-12036-96S	GMPR-12036-96A	5630	5-1/8"
	48"	42"	GMPR-4842-96S	GMPR-4842-96A	6590	3-5/16"
	96"	42"	GMPR-9642-96S	GMPR-9642-96A	7160	5-1/8"
	108"	42"	GMPR-10842-96S	GMPR-10842-96A	6420	5-1/8"
	120"	42"	GMPR-12042-96S	GMPR-12042-96A	5630	5-1/8"
	48"	48"	GMPR-4848-96S	GMPR-4848-96A	6590	3-5/16"
	96"	48"	GMPR-9648-96S	GMPR-9648-96A	7160	5-1/8"
	108"	48"	GMPR-10848-96S	GMPR-10848-96A	6420	5-1/8"
	120"	48"	GMPR-12048-96S	GMPR-12048-96A	5630	5-1/8"



Starter Unit

	Width	Depth	Starter Unit	Add-On Unit	Weight Capacity (lbs)	Beam Height
120" High	48"	42"	GMPR-4842-120S	GMPR-4842-120A	6590	3-5/16"
	96"	42"	GMPR-9642-120S	GMPR-9642-120A	7160	5-1/8"
	108"	42"	GMPR-10842-120S	GMPR-10842-120A	6420	5-1/8"
	120"	42"	GMPR-12042-120S	GMPR-12042-120A	5630	5-1/8"
	48"	48"	GMPR-4848-120S	GMPR-4848-120A	6590	3-5/16"
	96"	48"	GMPR-9648-120S	GMPR-9648-120A	7160	5-1/8"
	108"	48"	GMPR-10848-120S	GMPR-10848-120A	6420	5-1/8"
	120"	48"	GMPR-12048-120S	GMPR-12048-120A	5630	5-1/8"



Add-On Unit

	Width	Depth	Starter Unit	Add-On Unit	Weight Capacity (lbs)	Beam Height
144" High	48"	42"	GMPR-4842-144S	GMPR-4842-144A	6590	3-5/16"
	96"	42"	GMPR-9642-144S	GMPR-9642-144A	7160	5-1/8"
	108"	42"	GMPR-10842-144S	GMPR-10842-144A	6420	5-1/8"
	120"	42"	GMPR-12042-144S	GMPR-12042-144A	5630	5-1/8"

Wire Mesh Shelving (Supports Incl.):



Welded steel wire decks feature 2-1/2" x 4" wire openings with a gray finish and heavy gauge steel channel supports. Easily install wire decks by simply dropping them into place over beams.

To order:
Measure beam between uprights (left to right).
Measure beam depth overall (front to back).

Beam Length:	Use:
96"	Two 46"W
108"	Two 52"W
120"	Two 58"W
144"	Three 46"W

Width	Depth	Part Number	Capacity (lbs)
46"	36"	GMPR-4636-WMSH	2700
46"	42"	GMPR-4642-WMSH	2500
52"	36"	GMPR-5236-WMSH	2750
58"	36"	GMPR-5836-WMSH	2800
52"	42"	GMPR-5242-WMSH	2700
46"	48"	GMPR-4648-WMSH	2500
58"	42"	GMPR-5842-WMSH	2750
52"	48"	GMPR-5248-WMSH	2500
58"	48"	GMPR-5848-WMSH	2500

Front to Back Supports:



Length	Part Number
36"	GMPR-36-FBS
42"	GMPR-42-FBS
48"	GMPR-48-FBS

Heavy gauge front to back supports. Helps prevent undersized pallets from falling through. Supports drop into notches on beams.

GMCR Racks

Cantilever storage racks provide the perfect storage solution for bar stock, piping, and lumber. Upright assemblies constructed of heavy gauge steel are available in both single and double sided configurations. GMI offers a wide selection of upright heights and material storage arms to fit a variety of materials.



Features

- Heavy 11 Gauge Steel Construction
- All Welded Upright Frames
- Floor Anchor Holes
- Large Selection of Rack Arms Available
- 7 Gauge Shelf Arms - 600lb. Capacity
- Lower Base Serves as Bottom Shelf
- Standard Color is Charcoal Gray

Load Capacities

7 Gauge Arms - 600lb. Per Arm
Upright Support - 5500lb. Per

Racks are ordered in starter and add-on configurations. GMI offers several pre-configured racks to fit most applications or racks can be ordered by individual components.



How To Order:

- 1: Determine upright type, height and base.
Two uprights per starter, one per add on unit.
- 2: Choose arm length and type.
- 3: Order one brace set per bay. Brace sets are measured from center to center of uprights.

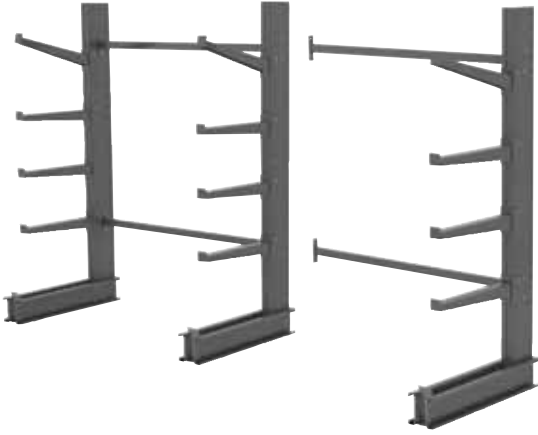

GMCR-100-10 - Single Sided Rack

- Single Sided Starter and Add-On
- Overall Size 38"D x 84"H
- 24"D - 7 Gauge Arms
- Available in 48", 60" and 72" Wide Assemblies
- 600lb Capacity Per Arm
- 5500lb Capacity Per Upright
- (3) Std (1) Incline Arms Per Upright
- Standard Color is Charcoal Gray

Model Number Starter Unit	Model Number Add-On Unit	Description
GMCR-100-10-48-S	GMCR-100-10-48-A	Single Sided Rack - 48"W
GMCR-100-10-60-S	GMCR-100-10-60-A	Single Sided Rack - 60"W
GMCR-100-10-72-S	GMCR-100-10-72-A	Single Sided Rack - 72"W

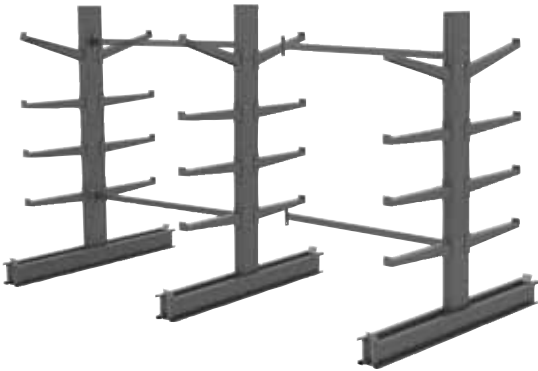

GMCR-200-10 - Double Sided Rack

- Double Sided Starter and Add-On
- Overall Size 59"D x 84"H
- 24"D - 7 Gauge Arms
- Available in 48", 60" and 72" Wide Assemblies
- 600lb Capacity Per Arm
- 5500lb Capacity Per Upright
- (6) Std (2) Incline Arms Per Upright
- Standard Color is Charcoal Gray

Model Number Starter Unit	Model Number Add-On Unit	Description
GMCR-200-10-48-S	GMCR-200-10-48-A	Double Sided Rack - 48"W
GMCR-200-10-60-S	GMCR-200-10-60-A	Double Sided Rack - 60"W
GMCR-200-10-72-S	GMCR-200-10-72-A	Double Sided Rack - 72"W

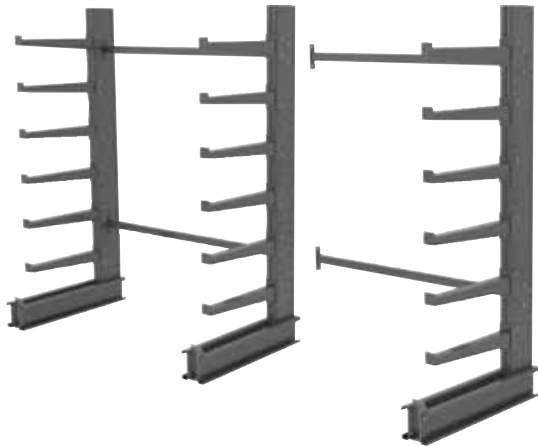

GMCR-100-20 - Single Sided Rack

- Single Sided Starter and Add-On
- Overall Size 38"D x 84"H
- 24"D - 7 Gauge Arms
- Available in 48", 60" and 72" Wide Assemblies
- 600lb Capacity Per Arm
- 5500lb Capacity Per Upright
- (6) Std Arms Per Upright
- Standard Color is Charcoal Gray

Model Number Starter Unit	Model Number Add-On Unit	Description
GMCR-100-20-48-S	GMCR-100-20-48-A	Double Sided Rack - 48"W
GMCR-100-20-60-S	GMCR-100-20-60-A	Double Sided Rack - 60"W
GMCR-100-20-72-S	GMCR-100-20-72-A	Double Sided Rack - 72"W

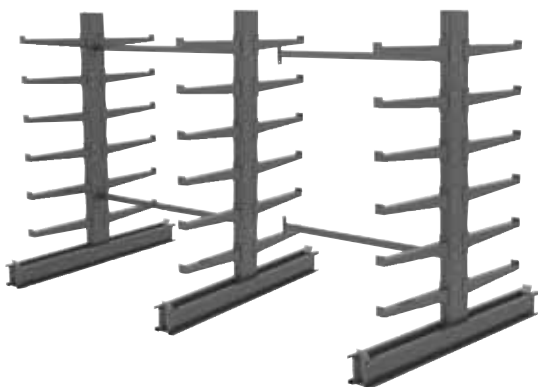

GMCR-200-20 - Double Sided Rack

- Double Sided Starter and Add-On
- Overall Size 59"D x 84"H
- 24"D - 7 Gauge Arms
- Available in 48", 60" and 72" Wide Assemblies
- 600lb Capacity Per Arm
- 5500lb Capacity Per Upright
- (12) Std Arms Per Upright
- Standard Color is Charcoal Gray

Model Number Starter Unit	Model Number Add-On Unit	Description
GMCR-200-20-48-S	GMCR-200-20-48-A	Double Sided Rack - 48"W
GMCR-200-20-60-S	GMCR-200-20-60-A	Double Sided Rack - 60"W
GMCR-200-20-72-S	GMCR-200-20-72-A	Double Sided Rack - 72"W

Units are Recommended to be Anchored

Rack Upright Supports

Base Depth	Height *	Max Arm Length *	Style	Model Number
36	36	24	Single Sided Upright	GMCR-100-36-36
36	36	12	Double Sided Upright	GMCR-200-36-36
38	60	24	Single Sided Upright	GMCR-100-60-38
50	60	36	Single Sided Upright	GMCR-100-60-50
62	60	48	Single Sided Upright	GMCR-100-60-62
59	60	24	Double Sided Upright	GMCR-200-60-59
83	60	36	Double Sided Upright	GMCR-200-60-83
107	60	48	Double Sided Upright	GMCR-200-60-107
38	72	24	Single Sided Upright	GMCR-100-72-38
50	72	36	Single Sided Upright	GMCR-100-72-50
62	72	48	Single Sided Upright	GMCR-100-72-62
59	72	24	Double Sided Upright	GMCR-200-72-59
83	72	36	Double Sided Upright	GMCR-200-72-83
107	72	48	Double Sided Upright	GMCR-200-72-107
38	84	24	Single Sided Upright	GMCR-100-84-38
50	84	36	Single Sided Upright	GMCR-100-84-50
62	84	48	Single Sided Upright	GMCR-100-84-62
59	84	24	Double Sided Upright	GMCR-200-84-59
83	84	36	Double Sided Upright	GMCR-200-84-83
107	84	48	Double Sided Upright	GMCR-200-84-107
38	96	24	Single Sided Upright	GMCR-100-96-38
50	96	36	Single Sided Upright	GMCR-100-96-50
62	96	48	Single Sided Upright	GMCR-100-96-62
59	96	24	Double Sided Upright	GMCR-200-96-59
83	96	36	Double Sided Upright	GMCR-200-96-83
107	96	48	Double Sided Upright	GMCR-200-96-107
38	120	24	Single Sided Upright	GMCR-100-120-38
50	120	36	Single Sided Upright	GMCR-100-120-50
62	120	48	Single Sided Upright	GMCR-100-120-62
59	120	24	Double Sided Upright	GMCR-200-120-59
83	120	36	Double Sided Upright	GMCR-200-120-83
107	120	48	Double Sided Upright	GMCR-200-120-107

Individual GMCR rack components can be configured to design the rack that best fits your application. Choose the desired types and size of rack uprights from the chart.



Double Sided Upright



Single Sided Upright

Rack arms are available in both a straight and incline configuration. Heavy 7 gauge arms are rated for 600 lbs each.

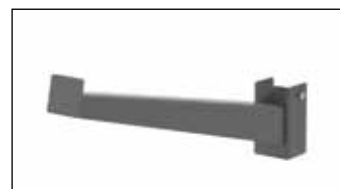

Incline Arm



Straight Arm

Shelf Arms

Model Number Heavy 7 Gauge Arm	Description	Size
GMCR-AR-24-00	Straight Arm - No Lip	24"
GMCR-AR-36-00	Straight Arm - No Lip	36"
GMCR-AR-48-00	Straight Arm - 1" Lip	48"
GMCR-AR-24-01	Straight Arm - 1" Lip	24"
GMCR-AR-36-01	Straight Arm - 1" Lip	36"
GMCR-AR-48-01	Straight Arm - 1" Lip	48"
GMCR-AR-24-02	Incline Arm - No Lip	24"
GMCR-AR-36-02	Incline Arm - No Lip	36"
GMCR-AR-48-02	Incline Arm - No Lip	48"

Upright Support Brace

Model Number	Description	Size
GMCR-BR-24	Upright Brace	24" Center to Center
GMCR-BR-36	Upright Brace	36" Center to Center
GMCR-BR-48	Upright Brace	48" Center to Center
GMCR-BR-60	Upright Brace	60" Center to Center
GMCR-BR-72	Upright Brace	72" Center to Center
GMCR-BR-84	Upright Brace	84" Center to Center
GMCR-BR-96	Upright Brace	96" Center to Center
GMCR-BR-120	Upright Brace	120" Center to Center



Upright Support Brace

Upright support braces are used with all rack upright configurations. Two braces are required per rack opening. Support braces can be mix matched to create varied bay widths.

GMCR-Work Bench

Cantilever rack based work bench is a unique design combining a material storage rack with a sturdy work bench. These work stations are ideal for areas that are limited on space and require the storage of materials in the work area. The shelf arms are adjustable to accommodate different materials. Benches are available in a variety of sizes and top configurations.

Features:

- Available with 2" pan folded steel or 1-3/4" maple hardwood top.
- 36" or 48" depth tops are standard.
- Straight shelf arms with stop.
- Four arms per upright.
- 700lb capacity per 7 gauge arm.

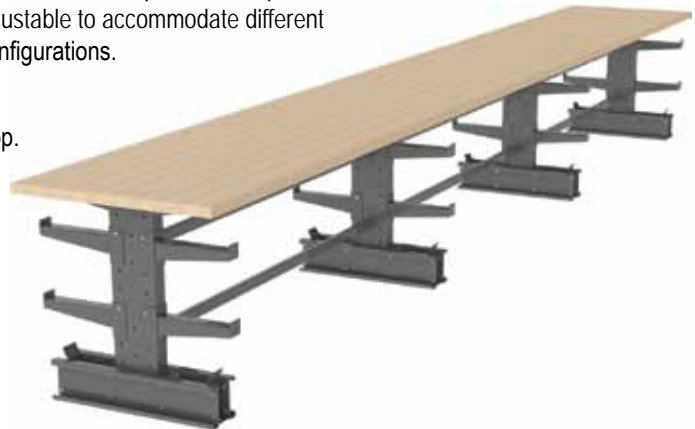

Shown with Steel Top

Model Number	Table Depth	Height	Table Length	Top Style	Arm Length	Number of Uprights
GMCR-3696.STL	36	42	96	Steel	12	2
GMCR-3696.M	36	42	96	Maple	12	2
GMCR-4896.STL	48	42	96	Steel	18	2
GMCR-4896.M	48	42	96	Maple	18	2
GMCR-36144.STL	36	42	144	Steel	12	3
GMCR-36144.M	36	42	144	Maple	12	3
GMCR-48144.STL	48	42	144	Steel	18	3
GMCR-48144.M	48	42	144	Maple	18	3

RR - Heavy Duty Rolling Rack

Constructed from heavy structural steel for excellent strength and durability. Perfectly suited for heavy automotive parts or die storage. Shelves feature heavy duty ball bearings that will handle loads up to 4000 lb. The positive locking safety feature locks each shelf in either the closed or fully extended shelf position and to ease in the loading and unloading of the shelves. These racks can be assembled in series with the addition of add-on units.

Features:

- 4000 lb Capacity per shelf
- Easy roll out shelves
- Shelves lock in open and closed position
- Adjustable shelf height
- Starter and add-on units

Description	Model Number Starter Unit	Model Number Add-On Unit
HD Rolling Rack - 42"W x 32"D x 80"H	RR-64MD-4232-80-3-S	RR-64MD-4232-80-3-A
HD Rolling Rack - 54"W x 32"D x 80"H	RR-64MD-5432-80-3-S	RR-64MD-5432-80-3-A
HD Rolling Rack - 66"W x 32"D x 80"H	RR-64MD-6632-80-3-S	RR-64MD-6632-80-3-A



Potting Work Bench

Designed to keep soils organized and off the floor while putting your plantings or arrangements together. The sturdy formed channel base features a galvanized steel work surface and upper riser shelf. Included are (3) soil bins and (1) trash receptacle. The work surface has a trash hole to allow excess soils or other debris to easily be cleared to the trash receptacle. The work station is available with a fixed or portable base.



A great work table for Landscape/Design or Horticulture programs.

Features:

- 30"D x 60"W x 27" to 38" Adjustable Height
- Soil Bins Measure 20"D x 15-1/2"W x 5"H
- 14 Gauge Galvanized Steel Upper Shelf
- 12 Gauge Galvanized Steel Work Surface
- 5" Heavy Duty Casters
- Large Trash Receptacle
- 3/4 Depth Lower Shelf

Model Number	Description
BA-305PS	30"D x 60"W Table - No Casters
BA-305PS-P	30"D x 60"W Table - With Casters



Shown with Optional Casters

Greenhouse Growing Tables

Growing tables feature a 13 gauge galvanized steel base frame with work surface supports. Sturdy formed channel adjustable height legs with floor anchor pads.

The plastic bench top is durable, smooth, non-porous, and allows trays, flats, and pots to slide across the surface without snagging. The interlocking panels will not rot, crack, splinter, or corrode. Available in a variety of sizes.



Durable Plastic Grate Work Surface.



Features:

- 27" to 38" Adjustable Height
- 14 Gauge Galvanized Steel Channel Frame
- Grated Plastic Work Surface
- Work Surface Supports
- Lower Leg Stringers
- Custom Sizes Available

Model Number	Description
BA-244-GRN-PL	24"D x 48"W Table
BA-248-GRN-PL	24"D x 96"W Table
BA-484-GRN-PL	48"D x 48"W Table
BA-488-GRN-PL	48"D x 96"W Table

Full Frame Support Under Work Surface.



Greenhouse Benches with Rolling Tops

Benches with rolling tops can help maximize space in your greenhouse. Benches feature heavy gauge galvanized steel legs with floor anchor pads. Leg kits for poured concrete mounting available. Hot dipped galvanized expanded metal work surface with aluminum table frame. Table rolls easily on full length roller bars. Available in 5' and 6' widths. Benches must be floor anchored.



Features:

- 32" Fixed Height Base
- Hot Dipped 13 Gauge Galvanized Steel
- Aluminum Table Frame
- Leg Mounting Brackets
- Special Sizes Available
- Easy Roll Table Top

Specify Floor Mount Type When Ordering

	Length	Part # Add PM (Post Mount) or FA (Floor Anchor)	Description
60"W	12'	B-6012-RGN-32_ _	60"W x 12'L x 32"H Rolling Greenhouse Table
	16'	B-6016RGN-32_ _	60"W x 16'L x 32"H Rolling Greenhouse Table
	18'	B-6018-RGN-32_ _	60"W x 18'L x 32"H Rolling Greenhouse Table
	24'	B-6024-RGN-32_ _	60"W x 24'L x 32"H Rolling Greenhouse Table
	30'	B-6030-RGN-32_ _	60"W x 30'L x 32"H Rolling Greenhouse Table
	36'	B-6036-RGN-32_ _	60"W x 36'L x 32"H Rolling Greenhouse Table
72"W	12'	B-7212-RGN-32_ _	72"W x 12'L x 32"H Rolling Greenhouse Table
	16'	B-7216RGN-32_ _	72"W x 16'L x 32"H Rolling Greenhouse Table
	18'	B-7218-RGN-32_ _	72"W x 18'L x 32"H Rolling Greenhouse Table
	24'	B-7224-RGN-32_ _	72"W x 24'L x 32"H Rolling Greenhouse Table
	30'	B-7230-RGN-32_ _	72"W x 30'L x 32"H Rolling Greenhouse Table
	36'	B-7236-RGN-32_ _	72"W x 36'L x 32"H Rolling Greenhouse Table

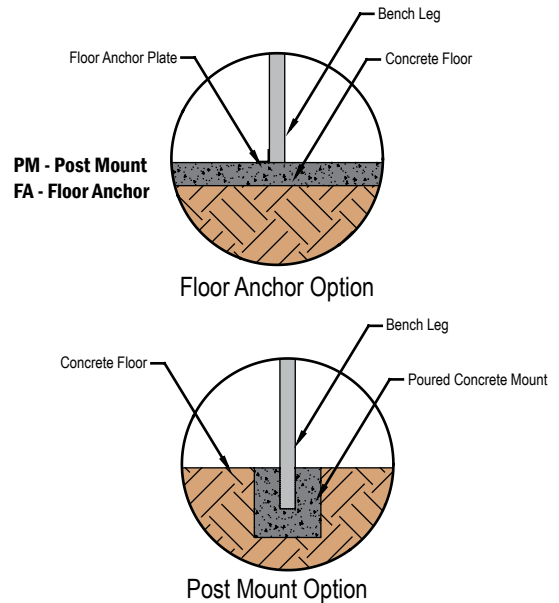

Greenhouse Galvanized Shelving

Features:

- Shelf units available in heights from 60"H to 96"H.
- Standard depths of 18" and 24".
- Formed 13 gauge galvanized steel uprights.
- Floor anchor pads.
- Perforated, reinforced 16 gauge galvanized steel shelves.
- Shelves adjust on 1-1/2" centers.

	# of Shelves (Steel)	Height	18" Deep	24" Deep
30"W	4	60	GRH-1830-60	GRH-2430-60
	4	72	GRH-1830-72	GRH-2430-72
	5	84	GRH-1830-84	GRH-2430-84
	5	96	GRH-1830-96	GRH-2430-96
36"W	4	60	GRH-1836-60	GRH-2436-60
	4	72	GRH-1836-72	GRH-2436-72
	5	84	GRH-1836-84	GRH-2436-84
	5	96	GRH-1836-96	GRH-2436-96
48"W	4	60	GRH-1848-60	GRH-2448-60
	4	72	GRH-1848-72	GRH-2448-72
	5	84	GRH-1848-84	GRH-2448-84
	5	96	GRH-1848-96	GRH-2448-96



Polyurethane Task Chair

Features:

- Ergonomic puncture and tear resistant seat and back rest.
- Adjustable height - Available in two height ranges.
- Back depth and height adjustment.
- Seat Dimensions: 18"W x 16.5"D / Backrest Dimensions: 17"W x 12"H
- 18" Dia. footring on lab height chair.
- Optional caster & armrest kits available.

Model Number	Description
GMI-1010580	Polyurethane Chair - Desk Height (Seat 17"H-21.5"H)
GMI-1010275	Polyurethane Chair - Lab Height (Seat 25"H-35"H)

Options:

Part Number	Description
GMI-1010243	Caster Kit (5 pk)
GMI-1010374	Padded Adj. Armrest Kit



GMI-1010580 Poly Shop Chair - Desk Height - No Foot Ring (Shown w/ optional casters)

GMI-1010275 Poly Shop Chair - Lab Height - 18" Dia. Footring

Upholstered Heavy Duty Task Stool w/ Backrest

Features:

- Ergonomic design promotes increased productivity.
- 1" Tubular chrome plated steel frame w/ 18" dia. foot ring.
- 26" to 34" pneumatic height adjustment.
- Back rest includes dual back bar with depth adjustment.
- Vinyl upholstered seat: 14" dia. x 3.5" thick / Backrest: 12"W x 6"H
- 300lb. seating capacity.

Model Number	Description
GMI-3010002	Adjustable Shop Chair with Back Rest



GMI-3010002 Shop Chair

Tube Frame Heavy Duty Shop Stool

Features:

- All welded 1" tube frame construction.
- Floor glides.
- Standard non adjustable seat height is 26".
- Adjustable height model range is 18" to 27"H.

Model Number	Description
GST-100.M	26"H Fixed Height Stool w/Maple Seat
GST-100.STL	26"H Fixed Height Stool w/Metal Seat
GST-100.M-ADJ	Adjustable Height Stool w/Maple Seat
GST-100.STL-ADJ	Adjustable Height Stool w/Metal Seat



GST-100.M w/Maple Seat



GST-100.STL w/Metal Seat

Task Stools

Features:

- Maple or cushioned poly seat options.
- Welded construction.
- 1-1/4" 16GA square tube legs.
- Curved steel backrest option.
- Textured black finish only.

Model Number	Description
GST-205.M	14" Maple Seat - 24"H Fixed Height
GST-205.M-ADJ	14" Maple Seat - Adjustable 22"H - 32"H
GST-205.M.BR	14" Maple Seat w/ Back Rest - 24"H Fixed Height
GST-205.M-ADJ.BR	14" Maple Seat w/ Back Rest - Adjustable 22"H - 32"H
GST-205.POLY	13" Poly Seat - 24"H Fixed Height
GST-205.POLY-ADJ	13" Poly Seat - Adjustable 22"H - 32"H
GST-205.POLY.BR	13" Poly Seat w/ Back Rest - 24"H Fixed Height
GST-205.POLY-ADJ.BR	13" Poly Seat w/ Back Rest - Adjustable 22"H - 32"H



GST-205.M
Maple Seat / Fixed Height



GST-205.POLY-ADJ
Poly Seat / Adj. Height



GST-205.M-ADJ.BR
Maple Seat / Back Rest /
Adj. Height



GST-205.POLY.BR
Poly Seat / Back Rest /
Fixed Height



Legs are fully welded to
12-gauge seat plate



Adjustable legs adjust
in 1" increments



Non-marring glides

Square Frame Heavy Duty Shop Stool

Features:

- All welded 1-1/4" 16GA square tube frame construction.
- Tempered hardboard seat cover.
- Floor glides.
- Standard non adjustable seat height is 26".
- Special heights available.

Model Number	Description
GST-83	26"H Fixed Height Stool
GST-83.1	26"H Fixed Height Stool with Back Rest



GST-83 Heavy Duty Square Stool



GST-83 Stool w/ Back Rest

Industrial Shop Chair

Features:

- Patented seat height adjustment from 17”H to 35”H (no tools required).
- Rugged design that will last in manufacturing settings.
- Large contoured polyurethane seat.
- Multi-level steel welded foot rest improves ergonomics at varying heights.
- 350lb. Seating capacity.
- Optional caster & armrest kits available.

Model Number	Description
GMI-1010315	Industrial Chair - Adj. Height (Seat 17”H - 35”H)

Options:

Part Number	Description
GMI-1010325	Caster Kit (5 pk)
GMI-1010330	Padded Adj. Armrest Kit



GMI-1010315 Industrial Shop Chair

Economy Industrial Shop Chair

Features:

- Adjustable height - Available in two height ranges.
- Rugged design that will last in manufacturing settings.
- Large contoured polyurethane seat & back rest.
- Welded foot rest.
- 300lb. Seating capacity.
- Optional caster & armrest kits available.

Model Number	Description
GMI-1010582	Econ. Industrial Chair- Desk Height (Seat 17.5”H-22”H)
GMI-1010347	Econ. Industrial Chair - Lab Height (Seat 21”H-31”H)

Options:

Part Number	Description
GMI-1010325	Caster Kit (5 pk)
GMI-1010330	Padded Adj. Armrest Kit



GMI-1010582 Desk Height



GMI-1010347 Lab Height

Laboratory / Healthcare Seating

Features:

- Antimicrobial vinyl seat and backrest.
- Seat: 16” Dia. x 3” thick / Back: 12”W x 6”H
- Durable twin wheel casters standard.
- Tubular 4 post base model w/ pneumatic lift.
- 5 Star base model w/ free spin mechanical lift height adjustment.
- 300lb. Seating capacity.

Model Number	Description
GMI-3010011	Tube Base (Seat Adj. 22”H - 26”H) - Mechanical Spin Lift
GMI-3010012	5 Star Base (Seat Adj. 18”H - 22”H) - Pneumatic Lift



GMI-3010011
Tube Base - Lab Chair



GMI-3010012
5 Star Base - Lab Chair

ESD & Non-ESD - Fabric Task Chairs

Features:

- ESD Chair requires no need for additional static protection.
- ESD Upholstered seat and back in a durable ESD fabric.
- Simple swivel & height adjustable seat control.
- Adjustable foot ring on lab height model only.
- 300lb. Capacity.
- Available in black, charcoal gray, and blue colored fabric.
- Non-ESD version comes with standard fabric and no drag chain.

Model Number	Description
GMI-1010452	ESD Chair - Desk Height (Seat Adj. 16"H - 21"H)
GMI-1010453	ESD Chair - Lab Height (Seat Adj. 20"H - 27.5"H)
GMI-1010600	NON-ESD Chair - Desk Height (Seat Adj. 16"H - 21"H)
GMI-1010601	NON-ESD Chair - Lab Height (Seat Adj. 20"H - 27.5"H)

Options:

Part Number	Description
GMI-1010375	ESD Hard Floor Caster Kit (5 pk)



GMI-1010452 ESD Chair - Desk Height



GMI-1010453 ESD Chair - Lab Height w/Footing

Desk & Conference Seating - Fabric Upholstered

Features:

- Durable fabric seat with molded foam seat cushion.
- Seat height range adjusts from 17"H - 21.5"H.
- Backrest height & depth manually adjust.
- Deluxe model includes seat tilt & back float ergonomic adjustments.
- 300lb. Capacity.
- Available in black, charcoal gray, and blue colored fabric.

Model Number	Description
GMI-1010576	Mid Back Chair w/ Floor Glides - Standard Adj.
GMI-1010577	Mid Back Chair w/ Floor Glides - Deluxe Adj.

Options:

Part Number	Description
GMI-1010243	Hard Floor Caster Kit (5 pk)



GMI-1010576 - Standard Mid Back Chair



GMI-1010577 - Deluxe Mid Back Chair

Deluxe Desk & Conference Seating

Features:

- Comfortable & ergonomic design.
- Fully adjustable mesh or molded foam w/ fabric backrest options.
- Commercial grade fabric seat w/ molded foam.
- Seat height range adjusts from 18"H - 21.75"H.
- Deluxe 2:1 synchro tilt w/ lock & tilt tension control.
- Adjustable armrest height and depth.
- Fabric back chair available in black, charcoal gray, & blue fabric.

Model Number	Description
GMI-1010461	Deluxe Mesh Back Desk Seating
GMI-1010591	Deluxe Fabric Back Desk Seating



GMI-1010461 - Mesh Desk Chair



GMI-1010591 - Fabric Desk Chair

Leg Pedestals



Leg Pedestal: 3-1/2" wide with 1" flange for mounting to work surface
 - Recessed 4"H kick riser with heavy-duty floor levelers - No electrical outlets
 - Available in both desk (28"H) and lab (34"H) heights.



Leg Pedestal with AC: 3-1/2" wide with 1" flange for mounting to work surface - Recessed kick riser with heavy-duty floor levelers - Includes (4) 15 amp - 120V grounded outlets, lighted on/off rocker switch, and 9' power supply cord with standard three prong plug - UL approved components - Available in both desk (28"H) and lab (34"H) heights.



Center Leg Pedestal: For use with corner configurations - 8" x 8" with 1" flange for mounting to work surface - Recessed kick riser with heavy-duty floor levelers - No electrical outlets - Available in both desk (28"H) and lab (34"H) heights.

Sample Part Number: DT-418

Depth	Height	Leg Ped No AC	Leg Ped w/AC	Center Pedestal
18"	DT (28"H) or DTL (34"H)	-- 418	-- 418AC	-- 88
21"		-- 421	-- 421AC	
24"		-- 424	-- 424AC	
28"		-- 428	-- 428AC	

Individual Bench Legs



Fixed Height Formed Channel Leg

Formed 14 gauge steel channel leg - Floor anchor pad - All welded assembly - Available in 28" or 34" heights.

Sample Part Number: DT-B18

Depth	Height	Model #
18"	DT (28"H) or DTL (34"H)	--B18
21"		--B21
24"		--B24
28"		--B28



Fixed Height "H" Series Leg

Constructed of 3" diameter 16 gauge round tube with 3/4" diameter cross supports - Floor levelers - All welded assembly - Available in 28" or 34" heights.

Sample Part Number: DT-H18

Depth	Height	Model #
18"	DT (28"H) or DTL (34"H)	--H18
21"		--H21
24"		--H24
28"		--H28



Fixed Height BTHD Series Leg

Constructed of 3" Square 16 gauge tube vertical upright supports - Floor levelers. All welded assembly - Available in 28" or 34" heights.

Sample Part Number: DT-BTHD18

Depth	Height	Model #
18"	DT (28"H) or DTL (34"H)	--BTHD18
21"		--BTHD21
24"		--BTHD24
28"		--BTHD28



Laminated Maple/Hardwood - 1-3/4" thick laminated strips of kiln-dried hardwood - Face glued - Two coat catalyzed varnish finish - Natural wood product, color may vary, subject to environmental conditions - Contact for details.



Steel Top with Fiber Cover - 12 gauge steel formed into a 2" thick work surface - Base mounting rails - Fiber cover prevents part marring - Ideal surface for assembly and general work areas - Fiber cover can be replaced.

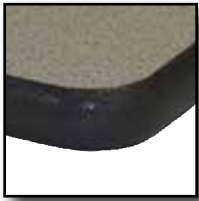

Plastic Laminate - 1-1/4" nominal overall thickness - High pressure laminate surface with balance backer sheet - 1-1/8" particle board core - Standard spray applied poly-urea edge - Plywood core tops available.

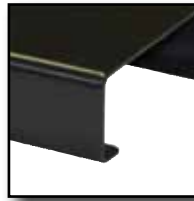

Steel Top - 12 gauge steel formed into a 2" thick work surface - Base mounting rails - Ideal for heavy work applications. Optional 1-7/8" wood core available.

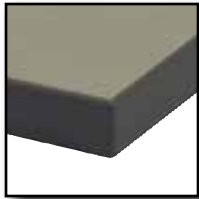

Plastic Laminate - 1" nominal overall thickness - High pressure laminate surface with balance backer sheet - 7/8" particle board core - 3mm PVC Edging.



Galvanized steel tops are formed into a 2" thick work surface. Available with optional 1-7/8" interior wood core - Ideal surface for assembly and automotive work areas. Galvanized top resists rust.



ESD Static Dissipative Laminate - 1-1/4" nominal overall thickness - High pressure laminate surface with balance backer sheet - 1-1/8" particle board core - Standard spray applied polyurea edge.

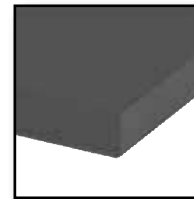

Epoxy Resin Tops - 1" nominal overall thickness - Provide maximum chemical resistance - Solid epoxy construction - Special mounting required - Does not accept all accessories - Contact factory for details and limitations.



Composition Tops - 1-3/4" nominal overall thickness - Top and bottom are 3/8" phenolic resin core sealed with catalyzed varnish - Edge glued lumber core.

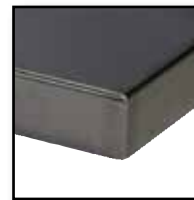

Stainless Steel Tops - 16 gauge stainless steel tops are formed into a 1-1/2" thick work surface - Plywood core - Ideal for wet or oily applications - Good chemical resistance.

Work Surface Type

M	1-3/4" Hardwood/Maple Top	C	2" Thick Composite Wood Top	E	1" Epoxy Resin - Black
L	1-1/4" Plastic Laminate Top with Spray Applied Edging	SF	2" Pan Folded 12 Gauge Steel Top w/Hardboard Cover	SS	1-1/2" 16 Gauge SS with #4 Brushed Finish
L3	1" Plastic Laminate Top with 3mm PVC Edging	S	2" Pan Folded 12 Gauge Steel Top	SP	Special Top Designation - Contact Factory for Details
LE	1-1/4" ESD Plastic Laminate Top w/ Spray Applied Edging	SG	2" Pan Folded 12 Gauge Galvanized Steel Top	WC	Add to Steel Top Part Number for Wood Core

Work Surfaces

Width	Model Number	Model Number	Model Number	Model Number	Model Number
48"	WS-2448_ _	WS-2848_ _	WS-3048_ _	WS-3648_ _	WS-4848_ _
54"	WS-2454_ _	WS-2854_ _	WS-3054_ _	WS-3654_ _	WS-4854_ _
60"	WS-2460_ _	WS-2860_ _	WS-3060_ _	WS-3660_ _	WS-4860_ _
72"	WS-2472_ _	WS-2872_ _	WS-3072_ _	WS-3672_ _	WS-4872_ _
84"	WS-2484_ _	WS-2884_ _	WS-3084_ _	WS-3684_ _	WS-4884_ _
96"	WS-2496_ _	WS-2896_ _	WS-3096_ _	WS-3696_ _	WS-4896_ _
120"	WS-24120_ _	WS-28120_ _	WS-30120_ _	WS-36120_ _	WS-48120_ _

Shelves

Width	Model Number	Model Number	Model Number
48"	SH-1248_ _	SH-1648_ _	SH-1848_ _
60"	SH-1260_ _	SH-1660_ _	SH-1860_ _
72"	SH-1272_ _	SH-1672_ _	SH-1872_ _
84"	SH-1284_ _	SH-1684_ _	SH-1884_ _
96"	SH-1296_ _	SH-1696_ _	SH-1896_ _
120"	SH-12120_ _	SH-16120_ _	SH-18120_ _

How To Order:

- 1: Determine desired work surface/shelf material.
- 2: Choose desired Width & Depth (see chart for common sizes / model numbers).
- 3: Add top material designation to model number from chart. EX: WS-3048.M is a 30"D x 48"W x 1-3/4" Maple/Hardwood work surface.

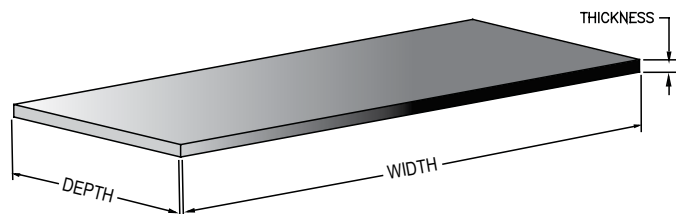



Riser Shelf Supports

Supports are 3.5"W - Sold in pairs - Available with optional AC power panel - Panel includes (5) outlet, 120V, 15 amp - lighted on/off switch - 6' cord & plug - Shelf sold separately on page 135.

	Height	Without AC	With AC
10" Deep	12"	DTR-1012	DTR-1012-AC
	16"	DTR-1016	DTR-1016-AC
	18"	DTR-1018	DTR-1018-AC
	24"	DTR-1024	DTR-1024-AC
16" Deep	12"	DTR-1612	DTR-1612-AC
	16"	DTR-1616	DTR-1616-AC
	18"	DTR-1618	DTR-1618-AC
	24"	DTR-1624	DTR-1624-AC



Ground Block

Mounts on any flat surface - Accepts (2) wrist straps - Mounting bracket and ground wire included.

Part #	Description
DTGB-40	Ground Block



Magnifier Task Light

Clamp mounts to shelf or work surface - 120V 15 amp fluorescent light - On/off switch - Cord with plug.

Part #	Description
DFXTL-100	Universal Magnifier Task Light



Foot Rest

Bolts to lower base riser assembly - Heavy gauge steel construction - Specify bench configuration when ordering - Special lengths available.

Part #	Description
DTF-36	36" Foot Rest
DTF-48	48" Foot Rest
DTF-60	60" Foot Rest
DTF-72	72" Foot Rest
DTF-84	84" Foot Rest
DTF-96	96" Foot Rest



Grounding Wrist Straps

Use for static control while working on sensitive equipment - Adjustable wrist strap and 5' coiled cord - Alligator ground clip.

Part #	Description
CG-100	One Wrist Strap and Cord



Power Cord Reel

30' Cord Reel - 125V/10A/1250W - (3) grounded electrical outlets - Can mount from Dura-Flex tool trolley or to back overhead rail - Optional mounting bracket to mount inside MG-Series cabinets.

Part #	Description
DTREL-100	Power Cord Reel
DTREL-BRK	MG-Series Mounting Bracket



Casters

Convert your work bench or storage cabinet to a mobile unit with optional caster kits. (2) swivel with brake and (2) rigid per kit. Available in standard 3", 4" or 5" casters. Special casters available upon request.

Part #	Description
DTCSTR - 3	3" Caster Kit
DTCSTR - 4	4" Caster Kit
DTCSTR - 5	5" Caster Kit



Under Shelf Light

Under shelf task lighting - 125V, 15 amp single tube up to 48" - Available for both hard wired and with optional cord/plug - On/off switch included with light fixture.

Part #	Description
DTSL-36	36" Light Fixture - Hardwire
DTSL-48	48" Light Fixture - Hardwire
DTSLC-36	36" Light Fixture - Cord/Plug
DTSLC-48	48" Light Fixture - Cord Plug



Cabinet Top Retainer Rail

2" high retainer rail provides a (3) sided back and end stop for all Dura-Tech and CB-series cabinets - Ideal for cabinets with caster kits - To order add the suffix (3RR) to the cabinet part number. (Ex: DT-3624-0400-**3RR**).

Part #	Description
3RR	Cabinet Retainer Rail



Adjustable Height Shelf Riser

Risers adjust from 12" to 18" H - 10"D for 12" shelf - Sold in pairs - Shelf and back stop sold separately - Order shelf separately on page 135.

Part #	Description
DTRADJ-48	48"W Adjustable Ht. Riser Assembly
DTRADJ-60	60"W Adjustable Ht. Riser Assembly
DTRADJ-72	72"W Adjustable Ht. Riser Assembly
DTRADJ-84	84"W Adjustable Ht. Riser Assembly
DTRADJ-96	96"W Adjustable Ht. Riser Assembly



Machinist Vice

Reversible jaws - 360 degree swivel base - Knurled jaw faces - Anvil worksurface - Pipe jaws set back for machinist use.

Part #	Jaw Width x Opening	Description
MV-260-CA	4" x 4-1/2"	Machinist Vice
MV-270-CA	5-1/4" x 5"	Machinist Vice



Under Mount Pencil Drawer

Drawer mounts to underside of work surface - Drawer measures 26"W x 20"D x 3.00"H - Integrated metal handle - Optional cylinder style lock.

Part #	Description
DTPD-20	Pencil Drawer
DTPD-20-L	Pencil Drawer with Lock



Work Surface Back & End Stop

Metal back stop measures 3"H above work surface - Can be used on both work surfaces and upper shelves - Mounts to edge of surface - Shown with adjustable riser shelf supports - Not for Epoxy work surfaces.

Part #	Description
DTBR-36	36" Rear Back Stop
DTBR-48	48" Rear Back Stop
DTBR-60	60" Rear Back Stop
DTBR-72	72" Rear Back Stop
DTBR-84	84" Rear Back Stop
DTBR-96	96" Rear Back Stop



Wood Workers Vice

Solid steel dog in front jaw - Machined toe in jaws provide solid grip - Fits up to 3" deep tops - Continuous action.

Part #	Jaw Size	Description
WV-470-CA	3-1/2" x 7"	Continuous Action Vice
WV-570-CA	3-1/2" x 10"	Continuous Action Vice



Cabinet Top Mats

Ribbed black rubber mats are non skid and grease resistant - For 24" deep cabinets.

Part #	Description
DTMT-120-24	Rubber Mat for 24"W Cabinet
DTMT-120-30	Rubber Mat for 30"W Cabinet
DTMT-120-36	Rubber Mat for 36"W Cabinet
DTMT-120-48	Rubber Mat for 48"W Cabinet



Steel Riser Shelf

Assembly measures 16"H x 15"D - Solid 16 gauge steel - Includes riser uprights and metal shelf.

Part #	Description
BRS-1615-48	48"W x 15"D x 16"H Riser Shelf
BRS-1615-60	60"W x 15"D x 16"H Riser Shelf
BRS-1615-72	72"W x 15"D x 16"H Riser Shelf
BRS-1615-84	84"W x 15"D x 16"H Riser Shelf



Flip Door Overhead Cabinet

Doors flip up and retract into the top of the cabinet - Cylinder style locks keep contents secure - Designed to mount on top of one of our 15"d BRS riser/shelf options.

Part #	Description
DTWOHC-24	24"W x 15"D x 16"H Cabinet
DTWOHC-30	30"W x 15"D x 16"H Cabinet
DTWOHC-36	36"W x 15"D x 16"H Cabinet
DTWOHC-42	42"W x 15"D x 16"H Cabinet



Drawer Liners

Black rubber mat drawer liners available in 24" wide rolls. Contact us for more info.

Part #	Description
DWRL-120	Roll Drawer Liner



Single Storage Drawer

Single storage drawer for under top mount - Drawer measures 16"W X 20"D - Available in depths listed below - Recessed plastic handle - Padlock hasp optional.

Part #	Description
DTP-6D	6" Deep Drawer No Lock
DTP-9D	9" Deep Drawer No Lock
DTP-12D	12" Deep Drawer No Lock
DTP-6DL	6" Deep Drawer w/ Lock
DTP-9DL	9" Deep Drawer w/ Lock
DTP-12DL	12" Deep Drawer w/ Lock



Air Hose Reel

Retractable hose reel with 25' 3/8" standard duty air line - 3/8" threaded fitting on both inlet and outlet - Mounting Bracket

Part #	Description
AR-25	Air Hose Reel



Plastic Tote Tray

Tote measures 13.75"W x 19"D x 4.375"H - Heavy gauge polyethylene material - Available in tan only.

Part #	Description
TOTE-1319	Single Tote Tray



LED Interior Cabinet Light

Adds interior light to tool cabinets - 120v x 15 amp circuit required - Optional on/off switch or automatic magnetic switch.

Part #	Description
ICL-M	Interior Light Kit - Manual Switch
ICL-A	Interior Light Kit - Auto Switch



Undermount Storage Cabinets

Constructed of 18 gauge steel with ball bearing drawer glides. Cylinder style locks are keyed alike and keep your contents safe and secure.

Description	Part #	Dimensions
Single Door	PC-5030	16"W x 16"H x 20"D
Two Drawer	PC-5330	16"W x 16"H x 20"D
Three Drawer	PC-5230	16"W x 16"H x 20"D
4 Drawer	PC-5130	16"W x 16"H x 20"D



Polyethylene Plastic Bins

Two standard sizes - Small bins measure 4.125"W x 7.375"D x 3"H - Large bins measure 8.25"W x 14.75"D x 7"H - Available in yellow only - Special sizes available upon request.

Part #	Description
GBN-4-Y	4.125"H x 7.375"D x 3"H - Small Bin
GBN-8-Y	8.25"H x 14.75"D x 7"H - Large Bin



Power Aprons

Aprons can be used with Dura-Flex or mount directly to work surface - Provides 120V-15 amp outlets with a lighted on/off switch - Provided with a cord & plug end.

Part #	Description
DTPA-24	24" Power Apron
DTPA-36	36" Power Apron
DTPA-72	72" Power Apron



Drop-In Drawer Organizer Kits

Made of high impact plastic, the red plastic box kits help organize parts & tools in drawers and allow you to easily remove the bins to the work area. Kits come in two popular assorted sizes.

Description	Part #	Bin Sizes / Qty
112 Piece Kit - 1-3/4" Deep	SCH-DOK-112-2	(64) 3"x3", (32) 3"x6", (16) 6"x6"
68 Piece Kit - 2-3/4" Deep	SCH-DOK-68-3	(32) 3"x3", (16) 3"x6", (12) 3"x8", (8) 6"x6"

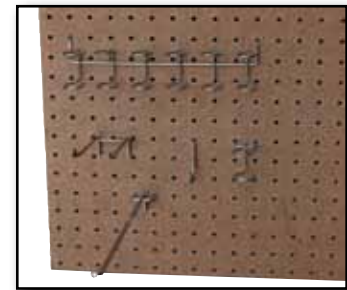

200 piece assorted tool hook kit that includes:
 50 - small "J" hooks 50 - medium "J" hooks
 25 - 4" straight hooks 25 - 2" straight hooks
 20 - single loop hooks 20 - angled hooks
 05 - loop racks 05 - hook racks

Part #	Description
PEG-200	200 Piece Hook Kit



Flat Panel Monitor Arm

Low-profile mounting system and integrated cable management - Snap-on cable shroud. Multi-directional swivel system - VESA standard mounting plate - Swivel adjustment on arm base and mounting head - Tension control knobs. Grommet mounting option included.

Part #	Description
DTFPMA-100	Flat Panel Arm - 12 lb Capacity



Keyboard Tray

Low profile design - Easy height control with patented spring-assisted counter balancing system (no knobs or levers) - Positive tilt lockout option - 360 degree swivel that allows user to move keyboard from side to side - Dual swivel option that keeps keyboard tray parallel to the desk.

Part #	Description
DTKBT-300	Keyboard Platform



Stationary CPU Rack

Fixed mount CPU rack with Velcro strap - Sturdy 12 gauge steel platform - Adapts easily to most GMI work benches.

Part #	Description
DTCPU-200	Stationary CPU Rack



Premium Flat Panel Monitor Arm

Five point adjustment provides a wide range of monitor positions and angles - Gas cylinder system "floats" the monitor above the desk. - Six mounting mechanisms are provided with each unit - Folds back into just 3.5" of space - Supports a wide range of monitors weighing anywhere from 4-24 lbs.

Part #	Description
DTFPMA-300	Flat Panel Arm - 24 lb Capacity



Keyboard Board Drawer

Drawer features a cushioned palm rest, and multi-position keyhole mounting brackets which allow installation at a variety of heights - Ball bearing slides have an end-of-travel lockout for secure full opening and ease of closing - The steel keyboard tray has a black finish.

Part #	Description
DTKBT-120	Keyboard Drawer



Slide/Swivel CPU Rack

Rack attaches to underside of work surface - Accommodates most tower CPU's - Locking clamp arm secures CPU into place - Durable metal slide and main support.

Part #	Description
DTCPU-400	Slide/Swivel CPU Rack



Premium Dual Flat Panel Monitor Arm

Dual arm provides five point adjustment and a wide range of monitor positions and angles - A gas cylinder system "floats" the monitor above the desk - Supports a wide range of monitors weighing anywhere from 4-24 lbs.

Part #	Description
DTFPMA-400	Dual Flat Panel Arm - 24 lb Capacity



Recessed Power Outlet

Recessed power outlet with (2) knock outs for RJ-45 or USB jacks - Unit supplied with power cord for 120V, 15 amp - Attached cover keeps dust out - Requires top cut out.

Part #	Description
DTCOM-300	Recessed Power Outlet



Surge Protected Outlets

Six outlet - 125V, 15 amp, 1875 watts - Lighted on/off switch - 48" power cord with plug - DPS-15 shown.

Part #	Description
DPS-15	15 Amp Six Outlet Surge Bar
DPS-15GFI	Six Outlet Surge Bar w/GFI
DPS-20	20 Amp Six Outlet Surge Bar

Standard Metal Finishes*

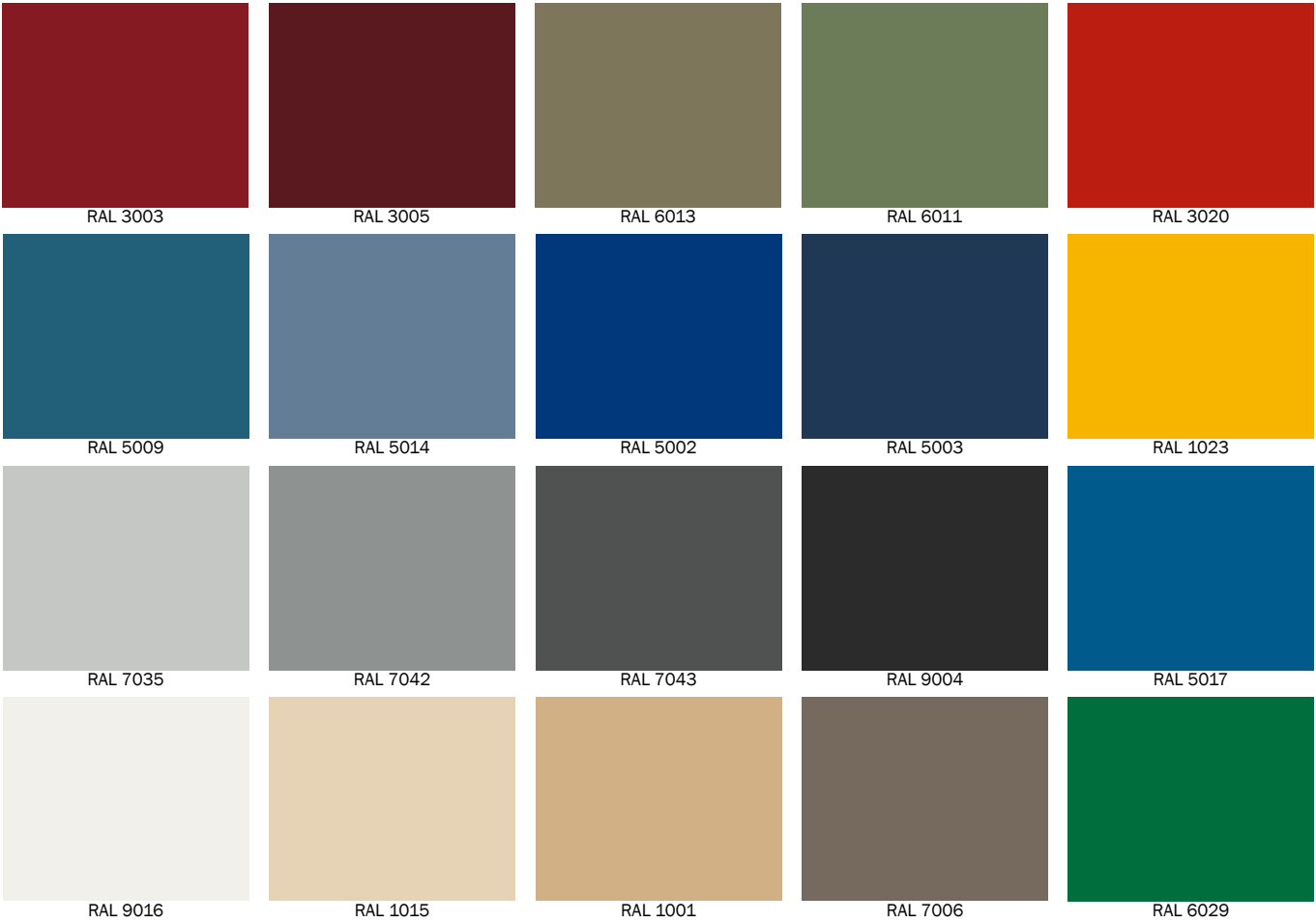

Popular Laminate Finishes*

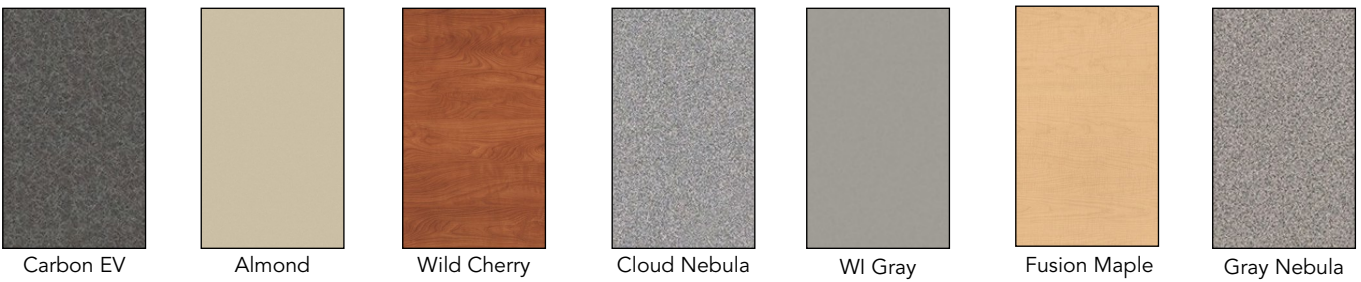

ESD - Static Dissipative Laminate Finishes*

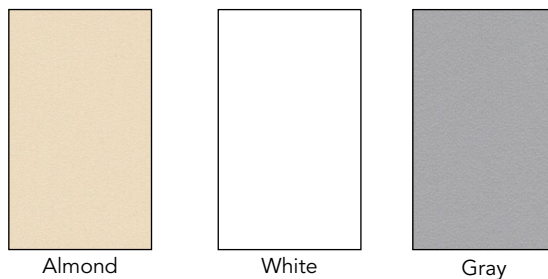

*Colors represented on this page are "closest match" due to printing constraints. Actual color samples are available upon request.

Warranty:

Greene Manufacturing, Inc. warrants to the original purchaser each product manufactured by Greene Mfg., Inc. against factory defect in materials and workmanship for the lifetime of the product from the date of purchase.

If your product should fail to operate properly for the intended and specific use during the warranty period, please notify GMI at the listed address or call our main office at (734) 428-8304.

If your product is found to have been consumer damaged or abused, it is not covered by the warranty and you will be advised in advance of the repair costs.

Greene Mfg., Inc.'s sole and exclusive liability for defects in material and workmanship shall be limited to repair or replacement by GMI upon our examination and sole discretion. Greene Mfg., Inc. shall in no event be liable for incident, consequential, contingent, or any other damages. This warranty shall not apply to any product that has been subject to abuse, misuse, negligence, accident, damage in shipment, or misapplication. This warranty does not obligate GMI to bear the cost of transportation or labor charges in connection with the repair or replacement of defective parts.

This warranty is invalid if the damage or defect is caused by an act of God, unauthorized alteration/repair, or vandalism.

This warranty is made in lieu of any other expressed warranty, and except for the foregoing warranty, which is exclusive, there is no other expressed warranty being made. Greene Mfg., Inc. reserves all rights to the warranty. The right is reserved to incorporate subsequent design or parts changes after publication and without reissue of descriptive literature or catalogs.

Returned Goods:

All returns must be authorized by GMI prior to shipment and accompanied by a GMI issued returned goods authorization number. All authorized returns must be shipped freight PREPAID via UPS or motor carrier. GMI will not accept C.O.D. returns. Provide documents stating the contents, reason for return and return authorization number. All items to be returned must be packed in original packaging and in compliance with motor carrier specifications. There are no cancellations or returns on custom or special order items. All cancellations and returned items must be received within 30 days of purchase date and are subject to a 25% restocking charge.

Taxes:

Greene Manufacturing, Inc. (GMI) reserves the right to add sales tax or any other tax that may be imposed upon our products as required by law. All shipments in the state of Michigan will carry the current sales tax rate unless an exemption certificate is on file with GMI.

Terms of Payment:

Payment terms are net 30 days upon credit account approval to established customers. Non-established customers must submit credit references before credit can be issued. Credit will be determined on the strength of the credit references and the minimum criteria set forth in GMI credit requirements.

Quotations:

All prices quoted are subject to receipt and acceptance of a valid, authorized purchase order 30 days for the date quoted unless otherwise noted.

Deliveries:

Delivery dates acknowledged by GMI are estimates base on current conditions at time of receipt of order, all technical data, and required approvals.

GMI makes no allowances, nor shall we be liable directly or indirectly for delays of carriers, labor difficulties, strikes, stoppages, shortages, accidents, fires, delays due to weather, Acts of God, government, material or manufacturing facilities or any circumstances beyond our control.

GMI will not be liable for any damages or penalties, whatsoever, direct or indirectly for delays caused by our failure to perform unless otherwise specifically agreed to in writing by an authorized officer of GMI.

Shipping Policy:

Terms are F.O.B. factory, Greene Manufacturing, Inc.'s responsibility to the merchandise ends when the transportation company issues its receipt to us. Freight claims must be made against the carrier by the consignee, GMI does not file freight claims.

All merchandise is packed in compliance with carrier requirements. Examine all shipments carefully BEFORE ACCEPTANCE. If there is any indication of damage or shortage, request the delivering carrier to make a notation to this effect on the freight bill BEFORE signing it. Should damage be discovered after delivery, retain all packaging materials and request immediate inspection by the delivering carrier. Valid claims for concealed damage must be reported within 10 DAYS FROM RECEIPT OF SHIPMENT. Once the delivering carrier has a clear receipt for a shipment, they are no longer responsible for any shortages or damages. Greene Manufacturing, Inc. cannot accept merchandise returned due to shipping damage.

WARNING: Products can expose you to chemicals including toluene, which is known to the State of California to cause reproductive toxicity.

Industrial Applications



Educational Applications



Educational Settings

Automotive Services



Agricultural and Greenhouse



Nursing and Medical



Material Storage



With over 50 years of precision metal fabrication experience, GMI is a leader in custom design, engineering and OEM builds for specialized fabricated solutions. From standard product modifications to complete design and build services, our staff of engineers and manufacturing specialists are ready to serve you. GMI will assist you in developing your ideas into reality.



Customized Tooling Holder



Specialized Material Handling



Custom Solutions: Break Room Cart



Ladder Storage Rack



Specialized Cabinet Interiors



Custom Configured Storage

Welding Equipment

Welding Booths • Welding Tables • Layout Tables • Ventilation • Cutting Tables • Grinding Stations



Computer & Office Furniture

Computer Desk • Art & Drafting • Instructor & Executive Desks • Conference & Gathering • Office Storage

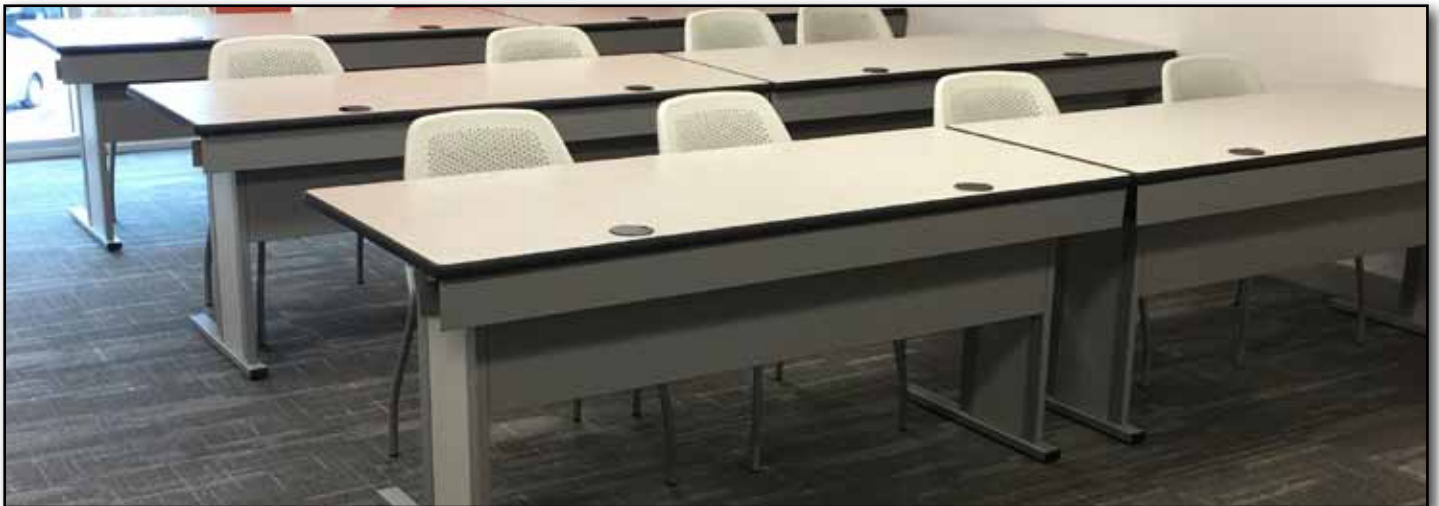

Cosmetology Labs

Styling / Barber Stations • Styling Chairs • Hair Wash Stations • Drying Chair • Manicure & Pedicure Stations





Greene Manufacturing, Inc.
3985 S. Fletcher Rd.
Chelsea, MI 48118

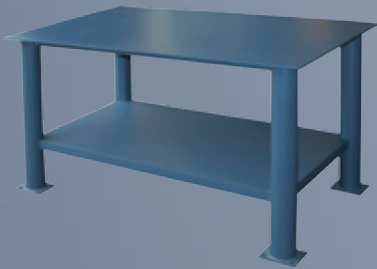

Contact Us for Info and Ordering:
info@greenemfg.com
www.greenemfg.com
800-396-4642



Made In
Michigan